

REF. 0504

(SOFT V02.0x)

OPERATING MANUAL

(Soft V02.0x)

Ref. 0504



Unauthorized copying or distributing of this software is prohibited.

All rights reserved. No part of this documentation may be transmitted, transcribed, stored in a backup device or translated into another language without Fagor Automation's consent.

Microsoft® and Windows® are registered trademarks of Microsoft Corporation, U.S.A.

PRELIMINARY WARNINGS



MACHINE SAFETY

It is up to the machine manufacturer to make sure that the safety of the machine is enabled in order to prevent personal injury and damage to the CNC or to the products connected to it.

On start-up and while validating CNC parameters, it checks the status of the following safety elements:

- *Feedback alarm for analog axes.*
- *Software limits for analog and sercos linear axes.*
- *Following error monitoring for analog and sercos axes (except the spindle) both at the CNC and at the drives.*
- *Tendency test on analog axes.*

If any of them is disabled, the CNC shows a warning message and it must be enabled to guarantee a safe working environment.

FAGOR AUTOMATION shall not be held responsible for any personal injuries or physical damage caused or suffered by the CNC resulting from any of the safety elements being disabled.



HARDWARE EXPANSIONS

FAGOR AUTOMATION shall not be held responsible for any personal injuries or physical damage caused or suffered by the CNC resulting from any hardware manipulation by personnel unauthorized by Fagor Automation.

If the CNC hardware is modified by personnel unauthorized by Fagor Automation, it will no longer be under warranty.



COMPUTER VIRUSES

FAGOR AUTOMATION guarantees that the software installed contains no computer viruses. It is up to the user to keep the unit virus free in order to guarantee its proper operation.

Computer viruses at the CNC may cause it to malfunction. An antivirus software is highly recommended if the CNC is connected directly to another PC, it is part of a computer network or floppy disks or other computer media is used to transmit data.

FAGOR AUTOMATION shall not be held responsible for any personal injuries or physical damage caused or suffered by the CNC due a computer virus in the system.

If a computer virus is found in the system, the unit will no longer be under warranty.

INDEX

1. GENERAL CONCEPTS

1.1	CNC configuration. Hardware.....	2
1.2	Turning the CNC on and off.....	4
1.2.1	Emergency shutdown with battery	5
1.3	Description of the keys	6
1.3.1	Keys associated with the information on the screen	6
1.3.2	Keyboard layout	7
1.3.3	Description of the operator panel	9
1.4	Directory structure	11
1.4.1	MTB (Machine Tool Builder) directory.....	12
1.4.2	USERS directory	13

2. HOW TO OPERATE THE CNC

2.1	Screen description.....	15
2.1.1	Detailed description of the CNC status bar	16
2.2	Operating modes.....	18
2.2.1	How to access to the operating modes	18
2.2.2	Description of the various operating modes.....	20
2.3	Dialog boxes.....	22
2.4	Windows for warnings and errors	23
2.5	File selection window.....	24
2.6	Calculator	27
2.6.1	Defining expressions.....	29
2.7	Keyboard shortcuts.....	32

3. AUTOMATIC MODE

3.1	Displaying the automatic mode	36
3.1.1	Description of the screens.....	37
3.1.2	Description of the general status bar	38
3.1.3	Channel synchronization window.....	39
3.1.4	Icon description (vertical softkeys)	40
3.2	Data screen	41
3.3	Data screen (softkeys).....	43
3.3.1	First block.....	43
3.3.2	Stop condition	44
3.3.3	Block search.....	46
3.3.4	Find text	48
3.3.5	Go to line	48
3.4	Graphic screen	49
3.5	Graphic screen (softkeys).....	51
3.5.1	Type of graphics.....	51
3.5.2	Zoom	52
3.5.3	Dimensions	54
3.5.4	Point of view	55
3.5.5	Measurement	56
3.5.6	Clear screen.....	56
3.5.7	Colors.....	57
3.5.8	Options.....	58
3.5.9	Real coordinates	59
3.6	Program selection and execution	60
3.6.1	Program selection	60
3.6.2	Program execution	61
3.6.3	Tool inspection	62
3.6.4	Block search and program execution.....	63



CNC 8070

(SOFT V02.0x)

4. MANUAL (JOG) MODE

4.1	Appearance of the Manual (JOG) mode.....	66
4.1.1	Description of a typical screen of this work mode.....	67
4.1.2	Vertical softkey menu (icons).....	68
4.2	Operations with the axes.....	69
4.2.1	Home search.....	69
4.2.2	Jogging the axes.....	71
4.2.3	Jogging the axes with handwheels.....	73
4.2.4	Moving an axis to a particular position (coordinate).....	75
4.2.5	Coordinate preset.....	76
4.3	Spindle control.....	77
4.4	Tool selection and tool change.....	78
4.5	Definition of cutting conditions.....	79
4.6	Automatic loading of zero offsets or fixture offset tables.....	80
4.7	Tool calibration.....	81
4.7.1	Tool calibration without a probe.....	82
4.7.2	Tool calibration with a probe.....	84
4.7.3	Calibration and wear measurement with probe.....	86

5. EDITING-SIMULATION MODE

5.1	Appearance of the editing - simulation.....	90
5.1.1	General screen description.....	91
5.1.2	Window description.....	92
5.1.3	Icon description (vertical softkeys).....	93
5.2	Editing window.....	95
5.2.1	Program editing.....	97
5.2.2	Import DXF files.....	99
5.2.3	Syntax errors when editing.....	101
5.3	Editing window (softkeys).....	102
5.3.1	Open program.....	102
5.3.2	File.....	103
5.3.3	Undo.....	105
5.3.4	Operations with blocks.....	106
5.3.5	Find/replace.....	107
5.3.6	Customizing.....	108
5.3.7	Profile editor.....	110
5.3.8	Canned cycles.....	111
5.3.9	TEACH-IN ON / TEACH-IN OFF.....	112
5.4	Graphics window.....	113
5.4.1	Program simulation.....	115
5.4.2	Simulation errors.....	117
5.5	Graphic window (softkeys).....	118
5.5.1	Type of graphics.....	118
5.5.2	Zoom.....	119
5.5.3	Dimensions.....	121
5.5.4	Point of view.....	122
5.5.5	Measurement.....	123
5.5.6	Clear screen.....	123
5.5.7	Colors.....	124
5.5.8	Options.....	125
5.5.9	Speed.....	126
5.6	Program window.....	127
5.7	Program window (softkeys).....	129
5.7.1	First block.....	129
5.7.2	Stop condition.....	130
5.7.3	Find text.....	132
5.7.4	Go to line.....	132
5.8	Statistics window.....	133
5.8.1	Time estimates.....	134



CNC 8070

(SOFT V02.0x)

5.9	Profile editor	135
5.9.1	Operating procedure	137
5.9.2	Data editing	138
5.9.3	Profile definition	139
5.9.4	Circular profile definition	140
5.9.5	Rectangular profile definition	141
5.9.6	Defining any profile	142
5.9.7	Modify a profile and insert corners	144
5.9.8	Display area	146
5.9.9	Work plane definition	147
5.9.10	End	148
5.9.11	Profile editor. Example 1	149
5.9.12	Profile editor. Example 2	150
5.9.13	Profile editor. Example 3	151
6.	MDI MODE	
6.1	Appearance of the MDI mode	154
6.1.1	Window description	155
6.2	Standard MDI window	156
6.2.1	Block editing and execution	157
6.3	Full MDI screen	158
6.3.1	Block execution	160
6.3.2	Save the blocks as a program	161
7.	USER TABLES	
7.1	Appearance of the table mode	164
7.1.1	Icon description (vertical softkeys)	165
7.2	Zero offset tables	167
7.3	Fixture table	169
7.4	Arithmetic parameter tables	170
7.5	Operations with tables	171
7.5.1	Data editing	171
7.5.2	Save and recall tables	172
7.5.3	Find text	173
8.	TOOL AND MAGAZINE TABLE	
8.1	Appearance of the tables associated with the tools and the tool magazines.	176
8.1.1	Table selection	177
8.1.2	Save and load the tables	178
8.2	Tool table	180
8.2.1	Icon description (vertical softkeys)	182
8.2.2	Tool table setting	184
8.2.3	Description of the tool table data	185
8.3	Operations with the tool table	191
8.3.1	Editing the tool table	191
8.3.2	Saving, loading and printing tables	193
8.3.3	Find text	195
8.4	Active-tools table	196
8.4.1	Changing the tool of the spindle	197
8.5	Table for the status of the tool change process	198
8.6	Magazine table	199
8.6.1	Icon description (vertical softkeys)	202
8.7	Operations with the magazine table	204
8.7.1	Loading / unloading tools to / from the magazine	204
8.7.2	Load and download a tool from the tool changer holders	206
8.7.3	Saving, loading and printing tables	207
8.7.4	Find text	209
9.	UTILITIES MODE	
9.1	Appearance of the utilities mode	212
9.1.1	Screen description	213
9.1.2	Window description	214
9.1.3	Vertical softkey menu (icons)	216

9.2	Utilities (Softkeys)	218
9.2.1	Sorted by.....	218
9.2.2	Options.....	218
9.2.3	Search in files.....	219
9.2.4	Select all.....	220
9.2.5	Invert selection	220
9.2.6	New folder	220
9.2.7	Protection passwords.....	221
9.2.8	Data safety backup. Backup - Restore.....	223

10. PLC

10.1	Appearance of the PLC mode	226
10.1.1	Screen description	227
10.1.2	Icon description (vertical softkeys)	228
10.2	"Programs" service	229
10.2.1	PLC project (softkeys).....	230
10.2.2	Files of the PLC project PLC (Softkey)	231
10.3	Program editing	232
10.4	Program editing (softkeys).....	233
10.4.1	Analyze	233
10.4.2	File	233
10.4.3	Undo.....	234
10.4.4	Operations with blocks	234
10.4.5	Find/Replace.....	235
10.4.6	Customizing	236
10.5	Program monitoring	238
10.6	Program monitoring (softkeys)	239
10.7	"Commands" service	240
10.7.1	Options of the "Commands" service (softkeys).....	240
10.8	"Outputs" service	241
10.8.1	Options of the "Outputs" service	242
10.9	"Logic analyzer" service	243
10.9.1	Editing logic analyzer data	245
10.9.2	Save, load and reset the analyzer configuration	248
10.9.3	Execute and analyze trace.....	249
10.9.4	Customize the appearance of the logic analyzer	250
10.10	"Monitoring" service	251
10.10.1	Description of resource tables.....	252
10.10.2	Definition of the table resources.....	254
10.10.3	Options of the "Monitoring" service (softkeys).	256
10.11	"Cross references" service	258
10.11.1	Options of the "Cross reference" service (softkeys).....	259
10.12	"Statistics" service	260
10.12.1	Options of the "Statistics" service (softkeys).....	261
10.13	"Messages" service	262
10.13.1	Options of the "Messages" service (softkeys).....	263
10.13.2	Editing the message and error table	264
10.13.3	Displaying PLC messages	265
10.13.4	Displaying PLC errors	266
10.13.5	Save, load and print a message and error table	267

11. MACHINE PARAMETERS

11.1	Appearance of the machine parameter tables.....	271
11.1.1	Icon description (vertical softkeys)	272
11.2	Parameter table description.....	274
11.2.1	"M" function setting table.....	275
11.2.2	Compensation table	276
11.3	Operations with tables	277
11.3.1	Data editing and validation.....	277
11.3.2	Save and recall tables.....	278
11.3.3	Find text	279



CNC 8070

(SOFT V02.0x)

12. SETUP ASSISTANCE

12.1	Oscilloscope	284
12.1.1	Interface description	285
12.1.2	Configuration screen	291
12.1.3	Configure and execute the oscilloscope function	292
12.1.4	Machine parameter editing	294
12.2	The Bode diagram	298
12.2.1	Interface description	299
12.3	The circularity (roundness) test	304
12.3.1	Interface description	305
12.3.2	Configuring and executing the circularity (roundness) test	308
12.3.3	Configure the graphic environment	309
12.3.4	Define and execute the movement subroutine	310
12.3.5	Data capture for the graphic	311
12.3.6	Adjustment of the machine parameters involved	313
12.3.7	Validate the changes and save the configuration used	315
12.3.8	Machine parameters that may be modified	316

13. DDSSETUP

13.1	Appearance of the DDSSetup mode	318
13.1.1	Screen description	319
13.1.2	Vertical softkey menu (icons)	320
13.2	List of drives	321
13.3	Command bar	322
13.4	Changing the drives accessing level	324
13.5	–Parameters and variables– service	325
13.6	–Error management– service	327
13.7	–Monitoring– service	328
13.8	–Information– service	329
13.9	Command generator	331

14. DIAGNOSIS

14.1	Appearance of the diagnosis mode	334
14.1.1	Screen description	335
14.1.2	Icon description (vertical softkeys)	336
14.2	Configuration diagnosis	337
14.2.1	System diagnosis	337
14.2.2	Software diagnosis	338
14.2.3	Hardware diagnosis. CAN bus and SERCOS	339
14.3	Sercos diagnosis	340
14.4	Save the CAN configuration for the start-up test	342
14.5	Generate a report with the system information	343

ABOUT THIS MANUAL

Title

Operating Manual.

Type of documentation

Description and operation of each table, windows and work modes of the CNC.

Internal code

It is part of the manual directed to the end user. The code of the manual depends on the software version –standard– or –advanced–.

CNC 8070 USER (IN) STAN Code 03753611

CNC 8070 USER (IN) AVANZ Code 03753631

Version

It corresponds to the software version: (Soft V02.0x).

Start-up



Verify that the machine that integrates this CNC meets the 89/392/CEE Directive.

Before starting up the CNC, read the instructions of chapter 1 in the Installation Manual.

Warning



The information described in this manual may be changed due to technical modifications.

FAGOR AUTOMATION, S. Coop. reserves the right to make any changes to the contents of this manual without prior notice.

FAGOR 

CNC 8070

(SOFT V02.0x)

ABOUT THE PRODUCT

Software options

Bear in mind that some of the features described in this manual depend on the software options that are installed.

	"M" model	"GP" model
Number of execution channels	1 to 4	1 to 4
Number of axes	4 to 28	4 to 28
Number of spindles	1 to 4	1 to 4
Number of tool magazines	1 to 4	1 to 4
COCOM version	Option	Option
Sercos digital drive system	Option	Option
Tool radius compensation	Standard	Option
"C" axis	Standard	Not available
RTCP transformation	Option	Not available
High speed machining (HSC).	Option	Option
Probing canned cycles	Option	Not available
Tandem axes	Option	Not available
Synchronism and cams	Option	Not available

VERSION HISTORY

Here is a list of the features added in each software version and the manuals that describe them.

The version history uses the following abbreviations:

- INST Installation manual
- PRG Programming manual
- OPT Operation manual

Software V01.0x

February of 2002

First version.

Software 1.1x

September of 2002

Feature	
Probe management through a digital input. It is not possible to manage it through the "Counter" module connector.	INST
Set the numbering of the digital I/O.	INST
Kinetics for rotary table.	INST
Possibility to park and unpark SERCOS axes from the PLC.	INST
Keyboard simulation from the PLC.	INST
New treatment of the JOG panel (Key + Direction).	INST / OPT
New machine parameters. <ul style="list-style-type: none"> • Probe setting. • Numbering of the digital I/Os. • Kinetics for rotary table. • Repositioning feedrate after a tool inspection. 	INST
New variables. <ul style="list-style-type: none"> • Probe setting. • Numbering of the digital I/Os. • Key simulation. • Repositioning feedrate after a tool inspection. • General scaling factor. • Kinetics dimensions. 	INST PRG
General scaling factor (#SCALE).	PRG
Probing canned cycles (#PROBE).	PRG
Probe selection (#SELECT PROBE).	PRG
Programming of warnings (#WARNING).	PRG
Block repetition (\$RPT).	PRG
Improved programming of high speed machining (#HSC).	PRG
Improved programming of axis swapping (#SET AX, #CALL AX, #FREE AX, #RENAME).	PRG
Macros: The number of macros in a program is now limited to 50.	PRG
Improved tool table.	OPT
Protection passwords.	OPT
Manual mode (jog). Tool calibration with or without probe.	OPT
Manual mode (jog). Automatic loading of zero offsets table.	OPT

FAGOR 

CNC 8070

(SOFT V02.0x)

Feature	
Manual mode (jog). Programming of feedrate "F" and spindle speed "S".	OPT
Axis selection/deselection for handwheel jog.	OPT
Theoretical path simulation.	OPT
Definition of the first block of a block search.	OPT
Confirm that the CNC is not in automatic mode when executing a program.	OPT
Syntax check in MDI.	OPT

January of 2005

Software: 2.0x

Feature	
Operation under Windows XP	INST
Emergency shutdown with battery (Central unit PC104)	OPT
New languages (Basque and Portuguese)	INST
Multi-channel system, up to 4 channels. <ul style="list-style-type: none"> Spindle swapping Axis swapping Communication and synchronization between channels. Common arithmetic parameters. Access to variables per channel. 	INST PRG OPT
Multi-spindle system, up to 4 spindles	PRG / INST
Tool management with up to 4 magazines.	INST
Tandem axis.	INST
New kinematics table-spindle (TYPE13 to TYPE16).	INST
New kinematics for C axis (TYPE 41 to TYPE 43)	INST
Parameter matching between the CNC and the Sercos drive	INST
New machine parameters. <ul style="list-style-type: none"> Warning level on Gantry axes (WARNCOUPE) Placing the vertical softkeys on the right or on the left (VMENU). Apply cross compensation to either theoretical or real coordinates (TYPCROSS). Apply leadscrew compensation to either theoretical or real coordinates (TYPLSCRW). Defining the default compensation mode (IRCOMP). Defining the type of reference pulse (REFPULSE). Memory sharing between applications (PLCDATASIZE). Generic OEM machine parameters (MTBPAR). Reading Sercos variables from the CNC (DRIVEVAR). Backlash peak compensation (BAKANOUT, BAKTIME, ACTBAKAN). 	INST
The behavior of rotary axes has been changed. Machine parameters AXISMODE, UNIDIR, SHORTESTWAY.	INST
Possibility of Sercos transmission at 8 Mhz and 16 Mhz. Parameter SERBRATE.	INST
Define the anticipation time for the axes to be considered to be in position. Machine parameter ANTIME and the PLC mark ADVINPOS.	INST
The "(V.).TM.MZWAIT " variable is not necessary in the subroutine associated with M06.	INST
Filters to eliminate the resonance of the spindle when it works as C axis or in rigid tapping.	INST
PLC. The TMOOPERATION may take the values 13 and 14.	INST
PLC. New mark MMCWDG to detect that the lockup of the operating system.	INST
PLC. Accessing arithmetic parameters and OEM parameters with CNCRD returns the value multiplied by 10000 (reading in float mode).	INST
PLC. The CNCEX command and the FREE mark to execute a CNC block.	
New commands at the PLC. <ul style="list-style-type: none"> New mark to disable the cross compensation tables (DISCROSS). New mark to correct the parallelism on Gantry axes (DIFFCOMP). Definition of external symbols (PDEF). 	INST
New variables. <ul style="list-style-type: none"> Software version. Variables to be set via PLC. Variables for adjusting the position. Fine adjustment variables. Feedback inputs. 	INST / PRG

Feature	
Electronic-cam editor.	INST
Optimize the reading and writing of variables from the PLC. Only the following will be asynchronous. <ul style="list-style-type: none"> The tool variables will be read asynchronously when the tool is neither the active one nor in the magazine. The tool variables will be written asynchronously whether the tool is the active one or not. The variables referred to local arithmetic parameters of the active levels will be read and written asynchronously. 	INST / PRG
Spindle parking and unparking.	INST
The RESETIN mark is not necessary to park/unpark axes or spindles from the PLC.	INST
Sercos control in velocity.	INST
Behavior of the beginning and end of tool radius compensation when not programming a movement.	PRG
Changing the type of radius compensation while machining.	PRG
Via program, loading a tool in a specific magazine position.	PRG
Programming of modal subroutines (#MCALL).	PRG
Executing a block in a channel (#EXBLK).	PRG
Programming the number of repetitions in the block (NR).	PRG
Direct resolution of 2D and 3D pockets without requiring a softkey.	PRG
Simulating a canned cycle of the editor separately.	PRG
New method to jog the axes using the JOG keyboard. Axis keys and independent directions.	INST / OPT
Importing DXF files from the program editor or from the profile editor.	OPT
Importing programs of the 8055/8055i CNC from the program editor.	OPT
Use a softkey to select the repositioning of the spindle after tool inspection.	OPT
Backup-restore utility.	OPT
Improved profile editor.	OPT
Assistance in the program editor. Contextual programming assistance. <ul style="list-style-type: none"> When programming "#", it shows the list of instructions. When programming "\$", it shows the list of instructions. When programming "V.", it shows the list of variables. 	OPT
Specific password for the machine parameters for kinematics.	OPT
Save the CAN configuration for testing it when starting up the system.	OPT
The diagnosis mode shows detailed information on the Sercos connection (Type and version of the drive and motor connected to it).	OPT
It is possible to print all the information on the configuration from any section of the diagnosis mode.	OPT
It is possible to simulate a cycle separately from the cycle editor.	OPT
Setup assistance. <ul style="list-style-type: none"> Oscilloscope. Bode diagram. Circularity (roundness) test. 	OPT

Feature	
New values of machine parameter SERPOWSE for the "Sercos II" board.	INST
Independent-axis programming commands.	INST
Electronic-cams programming commands.	INST
New signals that may be consulted and changed for the independent interpolator (electronic cam and independent axis)	INST
The simulated axes are ignored regarding the validation code.	
When unifying parameters, G00FEED and MAXVOLT are not sent out to the drive.	INST
Electronic-cam programming instructions (#CAM ON / #CAM OFF).	PRG
Independent-axis programming instructions (#MOVE ABS / #MOVE ADD / #MOVE INF / #FOLLOW ON / #FOLLOW OFF).	PRG
G112. Change the drive's parameter set .	PRG
DDSSETUP mode	OPT
G31. Temporary polar origin shift to the center of interpolation.	PRG

Version history



CNC 8070

(SOFT V02.0x)

DECLARATION OF CONFORMITY

Manufacturer:

Fagor Automation, S. Coop.

Barrio de San Andrés 19, C.P. 20500, Mondragón -Guipúzcoa- (SPAIN).

We declare:

under our responsibility that the product:

Fagor CNC8070 Numerical Control

meets the following directives:

Safety:

EN 60204-1

Machine safety. Electrical equipment of the machines.

Electromagnetic compatibility:

EN 50081-2

Emission.

EN 55011

Radiated. Class A, Group 1.

EN 55011

Conducted. Class A, Group 1.

EN 61000-3-2

Current armonics.

EN 61000-3-3

Flickers and Voltage fluctuations.

EN 50082-2

Immunity.

EN 61000-4-2

Electrostatic discharges.

EN 61000-4-4

Bursts and Fast transients.

EN 61000-4-5

High Voltage conducted pulses (Surges).

EN 61000-4-11

Voltage fluctuations and Outages.

EN 61000-4-3

Radiofrequency radiated electromagnetic fields.

EN 61000-4-6

Conducted disturbance induced by radio frequency fields.

As instructed by the European Community Directives 73/23/EEC, modification 93/68/ECC on Low Voltage and 89/336/CEE on Electromagnetic Compatibility.

In Mondragón on February 1st 2002.

Fagor Automation S. Coop. Ltda.
Director Gerente

Fdo.: Julen Busturia

FAGOR 

CNC 8070

(SOFT V02.0x)

SAFETY CONDITIONS

Read the following safety measures in order to prevent harming people or damage to this product and those products connected to it.

This unit may only be repaired by authorized personnel at Fagor Automation.

Fagor Automation shall not be held responsible of any physical damage or defective unit resulting from not complying with these basic safety regulations.

PRECAUTIONS AGAINST PERSONAL DAMAGE

- ❑ Interconnection of modules.
Use the connection cables provided with the unit.
- ❑ Use proper cables.
To prevent risks, use the proper cables for mains, Sercos and Bus Can recommended for this unit.
- ❑ Avoid electrical overloads.
In order to avoid electrical discharges and fire hazards, do not apply electrical voltage outside the range selected on the rear panel of the Central Unit.
- ❑ Ground connection.
In order to avoid electrical discharges, connect the ground terminals of all the modules to the main ground terminal. Before connecting the inputs and outputs of this unit, make sure that all the grounding connections are properly made.
- ❑ Make sure that it is connected to ground.
In order to avoid electrical shock, before turning the unit on verify that the ground connection is properly made.
- ❑ Do not work in humid environments.
In order to avoid electrical discharges, always work under 90% of relative humidity (non-condensing) and 45°C (113°F).
- ❑ Do not work in explosive environments.
In order to avoid risks or damages, do no work in explosive environments.

PRECAUTIONS AGAINST PRODUCT DAMAGE

- ❑ Working environment.
This unit is ready to be used in Industrial Environments complying with the directives and regulations effective in the European Community.
Fagor Automation shall not be held responsible for any damage suffered or caused when installed in other environments (residential or homes).
- ❑ Install the unit in the right place.

FAGOR 

CNC 8070

(SOFT V02.0x)

It is recommended, whenever possible, to install the CNC away from coolants, chemical product, blows, etc. that could damage it.

This unit complies with the European directives on electromagnetic compatibility. Nevertheless, it is recommended to keep it away from sources of electromagnetic disturbance such as:

- Powerful loads connected to the same AC power line as this equipment.
- Nearby portable transmitters (Radio-telephones, Ham radio transmitters).
- Nearby radio/TV transmitters.
- Nearby arc welding machines.
- Nearby High Voltage power lines.
- Etc.

❑ Enclosures.

The manufacturer is responsible of assuring that the enclosure involving the equipment meets all the currently effective directives of the European Community.

❑ Avoid disturbances coming from the machine tool.

The machine-tool must have all the interference generating elements (relay coils, contactors, motors, etc.) uncoupled.

❑ Use the proper power supply.

Use an external regulated 24Vdc power supply for the keyboard and the remote modules.

❑ Grounding of the power supply.

The zero volt point of the external power supply must be connected to the main ground point of the machine.

❑ Analog inputs and outputs connection.

It is recommended to connect them using shielded cables and connecting their shields (mesh) to the corresponding pin (see chapter 1 in the Installation Manual).

❑ Ambient conditions.

The working temperature must be between +5°C and +45°C (41°F and 113°F)

The storage temperature must be between -25°C y 70°C (-13°F y 158°F)

❑ Monitor enclosure.

Make sure that the gaps between the Central Unit and each wall of the enclosure are respected as indicated in chapter 1 of the Installation Manual.

Use a DC fan to improve enclosure ventilation.

❑ Main AC power switch.

This switch must be easy to access and at a distance between 0.7 and 1.7 m (2.3 and 5.6 ft) off the floor.



CNC 8070

(SOFT V02.0x)

PROTECTIONS OF THE UNIT ITSELF

❑ Remote modules.

All the digital inputs and outputs have galvanic isolation via optocouplers between the CNC circuitry and the outside.

PRECAUTIONS DURING REPAIR

- ❑ Do not get into the inside of the unit.

Only personnel authorized by Fagor Automation may manipulate the inside of this unit.

- ❑ Do not handle the connectors with the unit connected to AC power.

Before manipulating the connectors (inputs/outputs, feedback, etc.) make sure that the unit is not connected to AC power.

SAFETY SYMBOLS

- ❑ Symbols that may appear on the manual.



Symbol of danger or prohibition.

It indicates actions or operations that may hurt people or damage products.



Warning symbol.

It indicates situations that certain operations could cause and the suggested actions to prevent them.



Obligation symbol.

It indicates actions and operations that must be carried out.



Information symbol.

It indicates notes, warnings and advises.

- ❑ Symbols that the product may carry.



Ground protection symbol.

It indicates that that point must be under voltage.

WARRANTY TERMS

All products manufactured or marketed by Fagor Automation has a warranty period of 12 months from the day they are shipped out of our warehouses.

The mentioned warranty covers repair material and labor costs, at Fagor Automation facilities, incurred in the repair of the products.

Within the warranty period, Fagor Automation will repair or replace the products verified as being defective.

Fagor Automation is committed to repairing or replacing their products from the time they launch them up to 8 years after they disappear from the product catalog.

It is entirely up to Fagor Automation to determine whether a repair is to be considered under warranty.

Excluding clauses

The repair will take place at our facilities; therefore, all shipping expenses as well as travelling expenses incurred by technical personnel are NOT under warranty even when the unit is under warranty.

This warranty will be applied so long as the equipment has been installed according to the instructions, it has not been mistreated or damaged by accident or negligence and has been manipulated by personnel authorized by Fagor Automation.

If once the service call or repair has been completed, the cause of the failure is not to be blamed ON the FAGOR product, the customer must cover all generated expenses according to current fees.

No other implicit or explicit warranty is covered and FAGOR AUTOMATION shall not be held responsible, under any circumstances, of the damage which could be originated.

Service contracts

Service and Maintenance Contracts are available for the customer within the warranty period as well as outside of it.



CNC 8070

(SOFT V02.0x)

MATERIAL RETURNING TERMS

When sending the Central Unit or the Remote Modules, pack them in its original package and packaging material. If the original packaging material is not available, pack it as follows:

1. Get a cardboard box whose three inside dimensions are at least 15cm (6 inches) larger than those of the unit. The cardboard being used to make the box must have a resistance of 170Kg (375 lb.).
2. Attach a label indicating the owner of the unit, person to contact, type of unit and serial number. In case of malfunction also indicate symptom and a brief description of the problem.
3. Wrap the unit in a polyethylene roll or similar material to protect it.
When sending the Central Unit, protect especially the screen.
4. Pad the unit inside the cardboard box with poly-utherane foam on all sides.
5. Seal the cardboard box with packing tape or industrial staples.



CNC 8070

(SOFT V02.0x)

ADDITIONAL REMARKS

Mount the CNC away from coolants, chemical products, blows, etc. which could damage it.

Before turning the unit on, verify that the ground connections have been properly made.

In order to avoid electrical shock at the Central Unit, use the proper power (mains) cable. Use 3-wire power cables (one for ground connection).

In case of a malfunction or failure, disconnect it and call the technical service. Do not get into the inside of the unit.



CNC 8070

(SOFT V02.0x)

RELATED DOCUMENTATION

Manuals directed to the machine manufacturer or to the person in charge of doing the installation and start-up of the CNC.

Hardware manual.

It describes the hardware configuration and the technical data of each element.

Installation Manual.

It describes how to install and start up the CNC.

Manuals directed to the end user; that is, to the CNC operator.

Operating Manual.

Describes how to operate the CNC.

Programming Manual.

It describes how to program the CNC.

Examples manual.

It contains programming examples.

Other manuals, directed to the machine manufacturer and to the end user.

Manual for New Features.

It is optional. It describes the new features and modifications implemented since the version of the installation, operating and programming manuals.

Error solving manual.

It offers a description of the error messages that may appear on the CNC indicating the probable causes that originate them and how to solve them.

FAGOR 

CNC 8070

(SOFT V02.0x)

GENERAL CONCEPTS

1

This manual describes how to operate with the CNC using the keyboard, monitor and the operator panel. It also describes the various CNC operating modes as well as how to operate with each of them.



CNC 8070

(SOFT V02.0x)

1.1 CNC configuration. Hardware

1.

GENERAL CONCEPTS
CNC configuration. Hardware

▼ Monitor, keyboard and operator panel

The CNC assembly comprises the monitor, keyboard and the operator panel.

- The monitor shows the CNC's status and, in general, the information about the whole system.
- The keyboard is used to communicate with the CNC; the operator may request information on commands or change the CNC status using new instructions.
- The operator panel is used to govern the various elements of the machine, including the movement of the axes and the control of the spindle, etc.

▼ Modules

Depending on the CNC model, it may be connected in different ways. For example, it would be possible to connect devices such as:

- Floppy disk drive.
- CD-ROM unit.
- Printer.
- PC-compatible keyboard.
- Mouse with PS-2 connector.
- Devices with USB interface.
- Ethernet connection.
- Etc.

For further information, see the hardware manual.

Network connection (Ethernet)

The CNC may be connected to a computer network through specific connectors. The CNC must be configured as any node of the network as if it were a regular PC.

The following actions are possible when having a CNC configured as a node within the computer network:

- Access from any PC to the part-program directory of the CNC.
- Access from the CNC to any PC, to execute, simulate or edit programs. The program to be executed needs not be in the local disk.
- Copy programs and tables from the CNC to a PC and vice versa.
- Edit, modify, delete, rename, etc. the programs stored at the CNC.
- Perform a telediagnosis of the CNC.

1.

GENERAL CONCEPTS
CNC configuration. Hardware

FAGOR 

CNC 8070

(SOFT V02.0x)

1.2 Turning the CNC on and off

The way the CNC is turned on and off depends on how it has been set by the machine manufacturer. However, the most common way to do it is as follows.

1.

GENERAL CONCEPTS
Turning the CNC on and off

Turning the CNC on

After powering up the unit, the operating system (Windows 95 or Windows XP) will start up first. Then, and depending on how the manufacturer has set it, the CNC8070 application will either start up automatically or will have to be initiated by clicking on the icon shown on the screen.

While starting up, it will display the initial standard CNC screen or the initial screen created by the machine manufacturer for that purpose. Once the CNC is running, it will show the screen for the work mode (automatic or jog) selected by the machine manufacturer.

Turning the CNC off

To turn the CNC off, press the key combination [ALT]+[F4]. In any case, the CNC must not be turned off if there is any program in execution.

After closing the CNC application and depending on how the manufacturer has set it, the unit will turn off automatically or it will be required to select *Shut down the system* option of the *Start* menu.

Once the application is closed, the screen will show a message indicating to the operator that the unit may then be turned off.



The unit must be turned off with the on/off switch after having closed the application using the key combination mentioned earlier.

Turning the unit off incorrectly may cause the loss of information about:

- *Active offsets (zero offsets, part offset, etc.).*
- *Coordinates.*
- *Parts counter.*
- *Active axis sets.*
- *Information about the next tool.*

If on power-up, it displays the error " 12 - Checksum error in CNC data", it means that the CNC has been turned incorrectly (due to a power failure, etc.) and consequently that information has been lost:

When this error message is displayed, home (reference) the axes again and activate the offsets (part zero included) and the sets of axes.

1.2.1 Emergency shutdown with battery

The central unit PC104 is powered by an external 24Vdc power supply. Optionally, an external battery may be connected to ensure the detection of power supply voltage drops and that the unit is turned off properly.

When a power supply failure occurs (24V voltage drop) and there is a battery connected to the central unit, the latter responds as follows:

- If the supply is interrupted for less than 2 seconds.

The screens shows the corresponding warning and the system recovers fine. CAN errors may occur due to the lack of 24V at the remote modules.

- If the supply is interrupted for more than 2 seconds.

After the 2 seconds, the screen shows the corresponding error and it initiates the automatic turn-off sequence. First, it stops the machine if it is in execution. It closes the CNC8070 application, then the whole system and finally turns the battery off.

1.

GENERAL CONCEPTS

Turning the CNC on and off

1.3 Description of the keys

1.3.1 Keys associated with the information on the screen

Softkeys

The softkeys or functions keys may be used to select the different options shown on the screen.



Horizontal softkeys.

It selects the options of the horizontal menu.



Vertical softkeys.

It selects the options of the vertical icon menu.

Using the screens



Screen change.

Depending on how the OEM has set this key, it will be possible to perform one of the following operations.

- Sequentially access the different screens of the active work mode. In the PLC mode, it switches between the various active services.
- Sequentially access the different channels.
- The horizontal softkey menu shows the available screens and the vertical menu shows the available channels.



Window change.

It is used to switch between the different windows of the screen.



Previous menu.

On the horizontal softkey menu, it lets you go up from the softkey sub-menu to the previous level from where that menu was accessed.

Help



Help.

It accesses the CNC's system help.

1.









GENERAL CONCEPTS
Description of the keys

1.3.2 Keyboard layout

Depending on the utility of the different keys, the CNC keyboard may be considered to be laid out as follows.

Work modes

To access the different CNC work modes directly.

	Automatic mode.
	Jog mode.
	MDI mode.
	Editing - simulation mode.
	User tables. Zero offsets, fixtures and arithmetic parameters.
	Tool and magazine table.
	Utilities mode.
	Configurable mode. Depending on how the OEM has set this key it will be possible to: <ul style="list-style-type: none"> • Access a CNC work mode. • Execute an application. • Access the operating system. • Carry out no function at all.

Numeric keypad

It includes the necessary keys to enter numeric data and define the arithmetic operations as well as the following special keys:

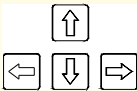
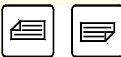
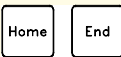
	Movement arrow keys. They move the cursor one position to the left, right, up or down.
	Previous or next page. They show the previous or next page when the program (part-program or PLC program) has more than one information page.
	Home and end keys. It moves the cursor the beginning or end of the line.

1.

GENERAL CONCEPTS
Description of the keys

Alphanumeric keyboard

It includes the necessary keys to edit programs as well as the following special keys:

1.

GENERAL CONCEPTS
Description of the keys

SHIFT

Shift key for capital letters.

By keeping it pressed and in combination with a another key, it accesses a second set of characters for that other key shown at the top of that key. When combined with a letter, it writes it in capital letters.

When combined with arrow keys, it selects the text the cursor slides on.

ALT GR

Alternate characters.

By keeping it pressed in combination with another key, it accesses the third set of character of the that key, shown at the bottom right of that key.

ALT

ASCII characters.

If a number is keyed in while keeping this key pressed, it will write the character corresponding to the ASCII code keyed in.

CAPS

Capital letters.

It toggles between uppercase and lowercase letters. It only affects alphabetical characters.



Delete character (back space).

It deletes the character to left of the cursor.

SUP

Deleted character.

It deletes the character to the right of the cursor or the selected text.

INS

Insert or overwrite.

It toggles between insert and overwrite modes. When inserting, the new text is added to the previous one, whereas when overwriting, the new text replaces the previous one.



Tab.

It moves the cursor to the next field of the active menu.

ESC

Escape key

It cancels the current operation without assuming the changes.

ENTER

Command validation.

It is used to validate the data of the current operation and the program blocks edited in editing - simulation mode.

RECALL

Data recall.

Having the TEACH-IN option active, it enters the axis position value into the block being edited.

When selecting a profile or conversational canned cycle in the part-program, it accesses either the profile editor or canned cycle editor accordingly.





1.3.3 Description of the operator panel

Depending on the utility of the different elements, the operator panel may be considered to be laid out as follows:





JOG keys

They are used to jog the axes. There are two types of JOG panels:

There are two keys for each axis. One to jog the axis in the positive direction and another one to move it in the negative direction.

		Jogging the axis in the positive direction. The movement is carried out at the jog feedrate.
		Jogging the axis in the negative direction. The movement is carried out at the jog feedrate.
		Rapid jogging of the axis. When combined with another JOG key, it moves the axis at rapid jog feedrate.

There is a key for each axis and two keys for moving direction, common to all the axes. Both keys (axis and direction) must be pressed to jog the axis.

		Axis selection.
		Selection of the moving direction.
		Rapid jogging of the axis. When combined with another JOG key, it moves the axis at rapid jog feedrate.

Feed selectors

The operator panel has two selectors:

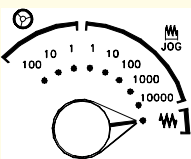
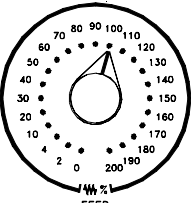
	Movement type selector. Select the type of jog movement, which may be either by handwheels, incremental jog or continuous jog. In handwheel mode, it selects the multiplying factor for the handwheel pulses (x1, x10 or x100). In incremental mode, it selects the incremental value of the axis movements.
	Feedrate override % selector. To select the override percentage to be applied to the programmed and jog feedrates, between 0% and 200%.

1.

GENERAL CONCEPTS
Description of the keys







CNC 8070



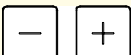

(SOFT V02.0x)

Spindle control

It is used to govern the spindle. It consists of the following keys.

	Start the spindle clockwise.
	To stop the spindle.
	Start the spindle counterclockwise.
	To vary the spindle speed percentually.
	Spindle orientation.

Execution keys

	Cycle start key. It executes the program selected in the execution mode regardless of the active work mode (except for MDI mode). If the program has been interrupted, it resumes its execution. If MDI mode is active, it executes the block just edited.
	Cycle stop key. It interrupts the execution of the program or the MDI block.
	RESET key. It initializes the system setting the initial conditions as defined by machine parameters.
	Single-block execution mode. It selects the single block execution mode. When this mode is active, the execution of the program is interrupted at the end of each block.
	Home search. It is used to reference (home) one or several axes at the same time using a subroutine.

External devices

The functions of these keys are defined by the machine manufacturer and they allow controlling the various devices of the machine (coolant, chip remover, etc.).

1.

GENERAL CONCEPTS
Description of the keys

1.4 Directory structure

The necessary files for the CNC are located in the directory C:\CNC8070 and its relevant subdirectories.

FAGOR Version directory

This directory contains the software corresponding to the CNC version installed.



Do not change the contents of this directory. Only authorized personnel from Fagor Automation may modify the contents of this directory.

Fagor Automation shall not be held responsible of the performance of this CNC if the contents of this directory have been changed.

Software updates are carried out in this directory and they do not affect the contents of directories MTB and USERS,

MTB OEM directory

This is especially directed at machine manufacturers.

This directory contains the modifications made by the machine manufacturer at the CNC like, for example, the PLC program, machine parameters, custom settings, new screens, integrating external applications, etc.

TMP Temporary files

This directory is used by the CNC to save the temporary files generated while operating.

The directory contents are erased every time the CNC is turned on.

USERS User directory

It is especially directed at users.

The purpose of this directory is to provide the user with a memory space for storing part-programs, profiles, etc. as they are generated.

UNINST Uninstall directory

This directory contains the necessary files to uninstall the software of the 8070 CNC.

To uninstall, double-click on the *firmain.exe* file and follow the instructions displayed on the screen.

1.

GENERAL CONCEPTS
Directory structure



CNC 8070

(SOFT V02.0x)

1.4.1 MTB (Machine Tool Builder) directory

This is especially directed at machine manufacturers.

This directory contains the modifications made by the machine manufacturer at the CNC like, for example, the PLC program, machine parameters, custom settings, new screens, integrating external applications, etc.

DATA

This directory contains:

- The databases for machine parameters, tables, etc. and the safety backup (in ASCII) of those tables.
- (*.dat) files related to the machining canned cycles (cycle editor).
- The copies made for storing data after turning the CNC off (coordinates, zero offsets, etc.)

DRIVE

This directory contains the information regarding the DDSSETUP.

MMC

This directory contains the CNC custom setting made by the machine builder:

- The directory "...MMC\CONFIG", the files that may be modified using the screen customizing tool (Fguim.exe).
- In the directory "...MMC\IMAGES", the machine builder may include all the files of the application regarding bitmaps, videos, icons, etc.

Initially, it will be a copy of the directory "...FAGOR\MMC".

PLC

This directory keeps the information regarding the PLC integrated by the machine builder:

- The directory "...PLC\LANG" contains the PLC messages and error messages in the different languages
- The directory "...PLC\PROJECT" contains the files that make up the PLC project and the object file.
- The directory "...PLC\WATCH" contains the sets saved from monitoring and the logic analyzer.

RELEASE

When the machine builder integrates his/her own application into the CNC, the components that have been created (*.OCX files) will have to be located in this directory.

SUB

When the machine builder integrates his/her own subroutines (tool change, home search, etc.), they will have to be located in this directory.

TUNING

This directory stores the configurations saved by the user in the setup assistance.

1.

GENERAL CONCEPTS
Directory structure



CNC 8070

(SOFT V02.0x)

1.4.2 USERS directory

It is especially directed at users.

The purpose of this directory is to provide the user with a memory space for storing part-programs, profiles, etc. as they are generated.

Although the user may store these programs in any directory, they should be saved in the directories created for this purpose in order to make it easier and faster to find them and make safety backup copies.

- POCKET** This directory saves the profiles that have been created using the profile editor and are related to the pockets of the conversational canned cycles.
- PRG** This directory saves the part-programs created by the user who may create new subdirectories and store the programs in a more orderly fashion.
- PROFILE** This directory saves the profiles that have been created using the profile editor and are related to conversational canned cycles.
- REPORTS** This directory saves the *bmp* files generated when printing a graphic image to a file. It also saves the reports (*prn* format) generated in the Diagnosis mode.



GENERAL CONCEPTS
Directory structure



CNC 8070

(SOFT V02.0x)

1.

GENERAL CONCEPTS

Directory structure



CNC 8070

(SOFT V02.0x)

2.1 Screen description

The CNC screens shows the following information:

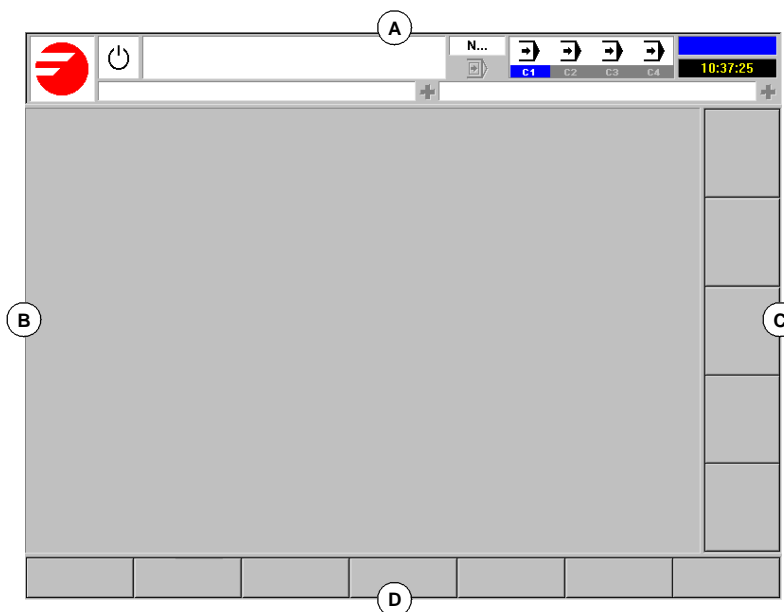

A. General CNC-status bar.

It shows the information on the program being executed, the active operating mode and the PLC messages. See "[Detailed description of the CNC status bar](#)" en la página 16.

B. Screen for the active work mode.

The information shown in this area depends on the active work mode (automatic, jog, etc.). The information shown in each work mode is described in the relevant chapter.

C. Vertical softkey menu (icons).

The menu options change depending on the active work mode. The different options are selected using softkeys F8 through F12.

This menu may be placed either on the left or on the right of the screen.

D. Horizontal softkey menu.

The menu options change depending on the active work mode. The different options are selected using softkeys F1 through F7.

2.1.1 Detailed description of the CNC status bar

The top of the screen shows the following information:

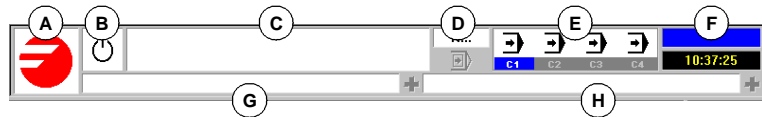

A. Icon (customizable) identifying the manufacturer.

B. Icon showing the status of the program of the active channel:

The background color will be different depending on the status of the program.



Programmed stopped.



Program in execution.

Background color: Green.



Program interrupted.

Background color: Dark green.



Program in error.

Background color: Red.

C. Program selected in the active channel for execution.

The background color will be different depending on the status of the program.

D. Number of the block in execution. The bottom icon indicates that the Single-block execution mode is active.

E. Information about the channels.

Number of channels available and active channel (indicated in blue). Icons show which operating mode each channel is in.



Execution mode.



Jog mode.



MDI mode.

The channel synchronization window may be expanded using the [ALT]+[S] keys. The synchronization is carried out using marks in the programs. The window shows for each channel whether it is waiting for synchronization marks or not and the status of those marks in the channel that originates them.

2.

HOW TO OPERATE THE CNC
Screen description



CNC 8070

(SOFT V02.0x)

An LED of various colors of the window show the status of the synchronization marks of each channel. On the left, the channels waiting for the marks and on top the channels that originate them.

- White No synchronization mark expected.
- Green Synchronization mark expected. The mark is set to 1 in the channel that originates it.
- Red Synchronization mark expected. The mark is set to 0 in the channel that originates it.

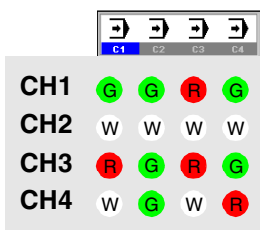

Channel 1 (CH1) is expecting synchronism marks from the rest of the channels. The marks of channels 2 and 4 are set to 1. The mark of channel 3 is set to zero.

Channel 2 is not expecting any synchronism mark.

(In the graphic, the white LED's are identified with the letter -W-, the green ones with the letter -G- and the red ones with the letter -R-).

F. Active work mode (automatic, manual, etc.) selected screen number and total number of screens available.

System clock.

G. Active CNC message.

For each channel, it shows the last message activated by the program that is running. The window shows the last message of the active channel. If there are messages in other channels, it will highlight the "+" sign next to the message window. To display the list of active messages, press the key combination [CTRL]+[O].

The list of messages shows, next to each message, the channel where it is active.

H. PLC messages.

If the PLC activates two or more messages, the CNC displays the message with the highest priority and it will show the "+" sign indicating that there are more messages activated by the PLC. To display the list of active messages, press the key combination [CTRL]+[M].

On the message list and next to each message, a symbol will appear to indicate whether the message has an additional information file associated with it or not. To display a message, select it with the cursor and press [ENTER]. If the message has an additional information file, it will be displayed on the screen.

2.

HOW TO OPERATE THE CNC
Screen description

2.2 Operating modes







2.2.1 How to access to the operating modes

The CNC operating modes may be accessed from the keyboard or from the task window that is displayed with the key combination [CTRL]+[A].

Each operating mode may consist of several screens or pages. Switching between the different screens is done by pressing the access key for that operating mode. Every time it is pressed, it displays the next screen. The screen selection is rotary in such a way that when pressing this key on the last screen, it shows the first one.

Accessing the operating modes from the keyboard

The following operating modes may be accessed from the keyboard.

-  Automatic mode.
-  Jog mode.
-  MDI mode.
-  Editing - simulation mode.
-  User tables.
-  Tool and magazine table.
-  Utilities mode.

Also, the keyboard has a special key that may be configured by the machine manufacturer to access their specific operating modes.

- 
 - Machine parameters.
 - PLC.
 - Diagnosis mode.
 - Setup assistance.

2.

Task window

All CNC operating modes may be accessed from the task window. Use the [CTRL] + [A] keys to open the task window. Press [ESC] to close the window without making a selection.

The task window looks like this.

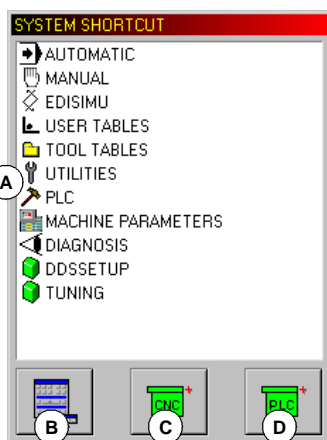

A. Available operating modes

B. Shows or hides virtual jog panel.

Same as using the [CTRL]+[J] key combination.

C. Expands the list of active CNC messages.

Same as using the [CTRL]+[O] key combination.

D. Expands the list of active PLC messages.

Same as using the [CTRL]+[M] key combination.

Moving around in the task window

Besides the mouse, the following keys may be used.

	To move the cursor thru the elements of the window.
	Moves the cursor over the list of operating modes.

After selecting an operating mode or one of the lower buttons, press [ENTER] to activate it.

2.

HOW TO OPERATE THE CNC
Operating modes

2.2.2 Description of the various operating modes

2.

Automatic mode

It is used to execute part-programs in automatic or single-block mode.

While executing a part-program, any other operating mode may also be accessed (except "MANUAL" and "MDI") without interrupting the execution of the program. This way, a program may be edited while another one is running (background editing). The running program cannot be edited.

Manual (jog) mode

It is used to control the machine movements manually using the keys of the operator panel, perform a home search, set the part zero, etc.

Editing - simulation mode

It is used for editing and simulating part-programs even while running another part-program.

MDI mode

It is used for editing and executing blocks in ISO code or in high-level language.

User tables

It is used for manipulating the CNC tables regarding part-programs (zero offsets, fixtures and arithmetic parameters).

Tool and magazine table

It is used to edit CNC tables regarding the tools and the tool magazine.

Utilities mode

It is used to handle CNC part-programs (copy, delete, rename, etc.).

A password may also be set to access the various operating modes.

Likewise, it offers the possibility to do a backup or a restore of the desired part of the disk.

PLC

It is used to operate with the PLC (edit a program, monitor, change the status of its variables, etc.).

Machine parameter table

It is used for setting the machine parameters to adapt the CNC to the machine.

Tuning mode. Setup assistance

For faster and easier machine setup.

This mode offers the axis adjustment guide, the circle test, the oscilloscope and the Bode graphs.

2.

HOW TO OPERATE THE CNC
Operating modes

FAGOR 

CNC 8070

(SOFT V02.0x)

2.3 Dialog boxes

2.

HOW TO OPERATE THE CNC
Dialog boxes

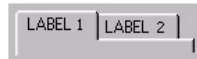

- Selection panels.

It selects among the different option groups within the same dialog box.

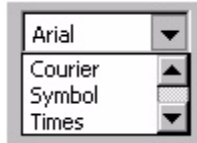

- Drop list.

It selects an option from a list. Clicking on the right icon, the list expands.

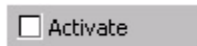

- Selection box.

It activates an option.

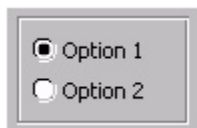

- Option selection.

It selects an option from a group. Selecting one cancels the previous one.



- Color pallet.

Select a color.

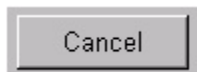

- Selection buttons.

They access a group of options or close the dialog box.

After making the changes, the dialog boxes are closed using one of the buttons that let you accept or reject the changes made.

Using the keyboard

The data of the dialog boxes are defined via keyboard as follows.

- Using the [CTRL]+[TAB] combination, it is possible to select different panels of the dialog box.
- The [TAB] key moves the cursor through the elements of the box.
- The [SPACE] key activates the selection boxes, selects an options and selects a color from the color pallet.
- The [ENTER] key presses the button that is selected.
- The [ESC] key closes the dialog box without accepting the changes.
- On the drop lists, the desired option may be selected using the keys on the keyboard.
- The arrow keys [←][→][↑][↓] move the cursor over the color pallet and over the options of a list.

2.4 Windows for warnings and errors

When an error occurs, the CNC will display a window describing the cause of the error. There are three types of errors. The top of the window shows the category and it will have a different color depending on the type of error it shows.

WARNING	Green window.
ERROR	Red window.
FATAL ERROR	Purple window.

When several warnings and/or errors occur simultaneously, they are displayed from the one with the lowest priority to the one with the highest priority. The top right side of the window shows the priority level of the message. A down arrow indicates that there are errors with lower priority and an up arrow indicates that there are errors with higher priority. The operator can toggle the different active errors using the [↑][↓] keys.

WARNING

It is just that, a warning.

They do not stop part-program execution and the warning window may be closed by pressing [ESC].

ERROR

It may be a syntax error in a program, PLC generated errors, etc. They are errors that must be corrected.

They interrupt the execution of the program. Although the window displaying them may be closed by pressing [ESC], it does not mean that the error status has been taken care of. To do that, press [RESET]. After pressing [RESET] the CNC assumes the initial conditions set by the machine manufacturer with the machine parameters.

While the error window is active, no other action will be possible but removing it (it is not possible to change operating modes).

Refer to the error solving manual for a detailed description of the cause of the error and its possible solutions.

FATAL ERROR

They are errors that force the operator to turn the CNC off.

If the error persists, contact the Service Department at Fagor Automation.

2.

HOW TO OPERATE THE CNC
Windows for warnings and errors

FAGOR 

CNC 8070

(SOFT V02.0x)

2.5 File selection window

The file selection window is common to all operating modes. This window is displayed when, from an operating mode, the operator selects the option to open, save or import a file, open or load a table, etc.

From this window, it is possible to either select an existing file or create a new one. A new file may be created only when it is a valid action. Depending on the operating mode it is accessed from, the list will only show the proper files.

2.

HOW TO OPERATE THE CNC
File selection window

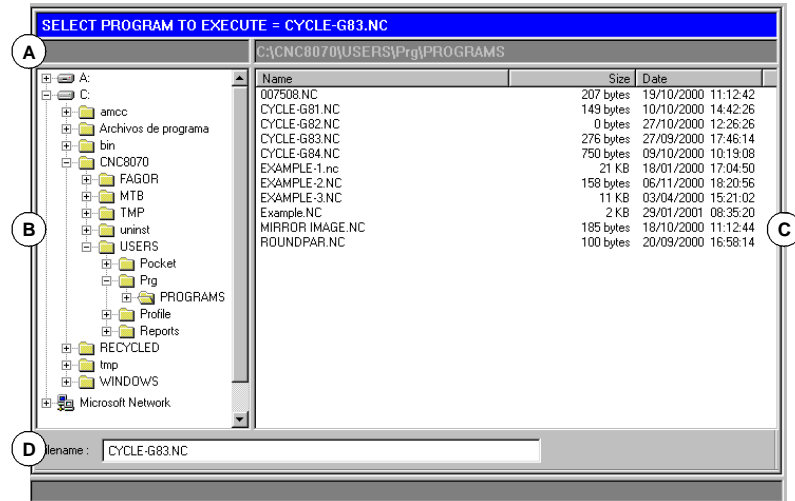

- A.** Type of file to be selected.
- B.** Folders accessible from the CNC, as well as how they are structured. It shows all the elements accessible from the CNC, such as the hard disk, floppy disk drive, CD-ROM unit, etc.
- C.** Files contained in the selected folder.
- D.** Area to define the name of the new files. A file can also be selected when knowing its name.

Move around in the window

Besides the mouse, the following keys may be used.

	It switches the window focus.
	With the focus on a folder, it closes and opens the submenu of folders.
	To move the focus through the elements of the window.
	To move the focus page by page.
	To move the focus to the beginning or end of the list.
	Opens the selected file.
	To cancel the selection and close the program listing.



CNC 8070

(SOFT V02.0x)

To select a file from the list

To make searching easier, the file list may be sorted according to different criteria. See "[Sorting the list of files](#)" en la página 25.

A file may be selected from the list:

1. Select the folder that contains the program.
2. Select the file from the list or write its name in the bottom window.
3. Press [ENTER] to accept the selection.

Pressing [ESC] cancels the operation at any time and closes the window.

How to search an element from the list

An element (folder or file) may be selected from the list by moving the cursor to the desired element or using an alphanumeric keyboard. Pressing a key will select the first element from the list starting with that letter or number. Pressing it again will select the second one and so on.

The files can also be selected using the "Find file" softkey. See "[File search](#)" en la página 26.

Creating a new file

To create a new file:

1. Select the destination folder for the file.
2. Write the file name at the bottom window.
3. Press [ENTER] to confirm the action.

Pressing [ESC] cancels the operation at any time and closes the window.

Sorting the list of files

The file list may be ordered alphabetically, by size or by date.

- When using a mouse, select the column header with the pointer. Every time the same header is selected, it toggles the sorting criteria from ascending to descending and vice versa.
- From the softkey menu. Every time the same softkey is selected, the CNC toggles the sorting criteria from ascending to descending and vice versa.

2.

HOW TO OPERATE THE CNC
File selection window



CNC 8070



(SOFT V02.0x)

File search

It is used to look for files whose names contain a particular character string. When selecting this option, the CNC shows a dialog box requesting the text to be found.



The programs are searched one by one. It may be searched using either the softkey menu or the following keys.

	To search for the next program (in descending order).
	To search for the previous program (in ascending order).
	To end the search and close the dialog box.

When defining a search, the softkey menu shows the "Next" and "Previous" options.

- Search next, it looks for the next program (in descending order).
- Search previous, it looks for the previous program (in ascending order).

Depending on how the search is carried out, the focus goes to the last file found, whose name also appears at the top of the window. To end the search, press [ESC].

2.

HOW TO OPERATE THE CNC
File selection window

2.6 Calculator

The calculator may be accessed from any task window or directly using the key combination [CTRL]+[K]. Press [ESC] to close the calculator.

The calculator may be accessed from any operating mode. When accessing from an editable element, the result displayed by the calculator may be inserted. An editable element is any element that may have a focus or cursor, such as the program editor, tables, editable data, etc.

To insert the result, press the [INS] key. It closes the calculator and inserts the result in the position that the cursor had when accessing the calculator.

2.

HOW TO OPERATE THE CNC
Calculator

The calculator looks like this

The calculator looks like this.



A. Results window. It shows the result of the expression after accepting it with the [ENTER] key.

This value may be recovered with the "Acc" button so it can be used in later calculations.

B. Editing window. It shows the expression being defined. The expression may consist of one or several operations that may be defined directly from the keyboard or with the softkey menu options.

It saves the list of the last operations.

C. Explorer window. It shows, at all times, the result from evaluating the expression being defined. When selecting a portion of the expression at the edit window, it will show the result from evaluating that portion.

The result from evaluating the expression may be:

OK: #####	Numeric.
OK: 1.#INF	Infinite.
Error: <>	Syntax error.
Wrong expression	Wrong expression.

Operations history

The expressions already accepted become part of the history and may be displayed using the relevant keys [↑][↓]. After selecting an expression from the window, press the [ENTER] key to recover it. The [ESC] key closes the history window.

2.

HOW TO OPERATE THE CNC
Calculator

Softkey menu

The softkey menu shows all the available operations. The expressions may be edited using either the softkey menu or the mouse with the calculator keys.

Work units

The result of the operations may be given in various units. Use the following icons to change the units. It highlights the units currently selected.

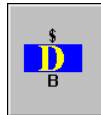

Hexadecimal (\$), decimal (D) or binary (B) units.

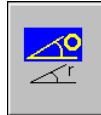

Units in degrees or radians.

2.6.1 Defining expressions

An expression may consist of one or more operations. Each one of them may be defined by any valid combination of variables, constants, functions and operations.

Press [ENTER] To accept the expression entered and calculate the value.

Quick parenthesis insertion

To place a portion of an expression between parenthesis, select the portion and press one of the parenthesis keys "(" or ")".

If while a portion of the expression is selected, an operation key is pressed, the selection will appear between parenthesis and it will be preceded by the operation just defined.

Example: Having the expression "1+1/X+1/(X+1)+1". When selecting the "1/(X+1)+1" portion and pressing the "SIN" option, the expression will become "1+1/X+Sin(1/(X+1)+1)".

Variables for the calculator

Up to 26 variables (from "A" to "Z", except "Ñ",) may be used to store numeric values and use them later.

Assigning a value to a variable: A = 34.234

Reference to a variable: Sin(A/2)

A single expression may contain both assignment and reference operations. Use the ":" character as separator.

A=34.234:Sin(A/2) is the same as Sin((A=34.234)/2)



The values of the calculator variables "A" - "Z" are independent from the values of local parameters "A" - "Z" (also called P0 through P25).

Constants

The following constants are available and they may be accessed from the softkey menu.

PI	Value of pi (3.14159...)
MM -> INCHES	mm/inch conversion factor.
INCHES ->MM	inch/mm conversion factor.

2.

HOW TO OPERATE THE CNC
Calculator



CNC 8070

(SOFT V02.0x)

Various operations

In the following examples, the "x" and "y" values indicate any valid combination of constants, variables or expressions.

Binary operations.

AND	Binary AND	1001 AND 1010 = 1000
OR	Binary OR	1001 OR 1010 = 1011
XOR	Exclusive OR	1001 XOR 1010 = 0011
NOT	Inverse	NOT 101 = 1...1010

Arithmetic operations.

$x + y$	Add	
$x - y$	Subtract	
$x * y$	Multiply	
x / y	Divide	
$x \% y$	Percentage	10%50 = 5
$x ^ y$	Power	2^3 = 2 * 2 * 2 = 8
$x!$	Factor	3! = 3 * 2 * 1 = 6

Trigonometric operations.

SIN(x)	Sine	SIN 30 = 0.5
COS(x)	Cosine	COS 60 = 0.5
TAN(x)	Tangent	TAN 45 = 1
INV SIN(x)	Arc-sine	InvSin 0.5 = 30
INV COS(x)	Arc-cosine	InvCos 0.5 = 60
INV TAN(x)	Arc-tangent	InvTan 1 = 45

Conversion functions.

MM -> INCHES	It converts from millimeters to inches.
INCHES ->MM	It converts from inches to millimeters.
ABS(x)	Absolute value.
INT(x)	Integer.

Extended functions

SQRT x	Square root	SQRT 16
LN x	Neperian log	LN 100
LOG x	Decimal log.	LOG 100
$e ^ x$	"e" function	InvLn 3
$10 ^ x$	Decimal exponent	InvLog 50
INTEGRAL x	It calculates the integral	N=100:A=1:B=5:Integral(x+2)
ZERO x	Function zero	N=100:E=1e-10:A=5:Zero(x^2)

2.

HOW TO OPERATE THE CNC
Calculator



CNC 8070

(SOFT V02.0x)

INTEGRAL function

It returns as result, the integral defined by the function between the limits defined by the "A" and "B" variables.

The precision of the result depends on the "N" variable, that indicates the number of intervals used to divide the function in order to calculate the integral. If "N" is less than or equal to zero, it will be ignored and the number of intervals will be 100. If "N" is greater than 500000, the intervals will be 500000.

ZERO function

It returns as result, the value that makes the function to be zero. Since there may be several values satisfying this condition, the result will depend on the initial value of the exploration defined with the "A" variable.

The precision of the result depends on the "N" variable that indicates the number of iterations of the resolution algorithm. If "N" is less than or equal to zero, it will be ignored and the number of iterations will be 100. If "N" is greater than 500000, the intervals will be 500000.

The "E" variables define the error allowed so the result of the function with the calculated value is smaller than "E". This variable is useful when not knowing what value to assign to "N". In that case, it is recommended to assign to "N" a very large value and to "E" the error allowed.

2.

2.7 Keyboard shortcuts

2.

HOW TO OPERATE THE CNC
Keyboard shortcuts









Operations at the interface

To perform different operations with the CNC.

- [CTRL] + [W] Minimize/Maximize the CNC.
- [CTRL] + [J] Show / hide the virtual operator panel.
- [CTRL] + [M] Show / hide the PLC message list.
- [CTRL] + [O] Show / hide the CNC message list.
- [ALT] + [F4] Turn the CNC off.





Work modes

To select the CNC operating modes.





-  [CTRL] + [A] To show the task window.
-  [CTRL] + [F6] Automatic mode.
-  [CTRL] + [F7] Jog mode.
-  [CTRL] + [F8] MDI mode.
-  [CTRL] + [F9] Editing - simulation mode.
-  [CTRL] + [F10] User tables.
-  [CTRL] + [F11] Tool and magazine table.
-  [CTRL] + [F12] Utilities mode.
- [CTRL] + [K] Calculator.

CNC keys

Same as pressing the following CNC keys

-  [CTRL]+[F1] Previous menu.
-  [CTRL]+[F2] Switch window.
-  [CTRL]+[F3] Switch screens.
-  [CTRL]+[F5] [RECALL] key.

Same as pressing the following keys of the operator panel.

-  [CTRL]+[S] [START] key.
-  [CTRL]+[P] [STOP] key.
-  [CTRL]+[R] [RESET] key.
-  [CTRL]+[B] "Single block" execution key.

Program editor

Keyboard shortcuts available at the part-program and PLC program editor.

- [CTRL]+[TAB] Toggle between the editor and the error window.
- [CTRL]+[C] Copy the selected text onto the clipboard.
- [CTRL]+[X] Cut the selected text.
- [CTRL]+[V] Paste the selected text.
- [CTRL]+[Z] Undo the last change.
- [CTRL]+[G] Save the program/Recover the original program.
- [CTRL]+[HOME] Move the cursor to the beginning of the program.
- [CTRL]+[END] Move the program to the end of the program.

2.

HOW TO OPERATE THE CNC
Keyboard shortcuts

2.

HOW TO OPERATE THE CNC Keyboard shortcuts



CNC 8070

(SOFT V02.0x)

Automatic mode selection



The automatic mode may be selected from any other operating mode by pressing its relevant key.

This work mode may be accessed from any channel and even from several channels at the same time. A different program may be executed in each channel.

From the automatic mode, and even while a program is in execution, it is possible to access another work mode except the JOG mode and the MDI mode. If program execution has been interrupted (either because it is being executed in "single block" mode or because the [STOP] key has been pressed), the CNC cancels the execution of the program and goes into jog mode.

Operations in automatic mode

The following operations are possible in this work mode:

- Select and execute a part-program.
The execution may be carried out in -automatic- mode or in -single block- mode.
- Set the execution conditions (first and last blocks) before executing the program.
- Searching a block.
Recover the history of a program up to a particular block and then resume program execution from that block.
- Display various data related to axes position.
(Command, position referred to part zero or to home, following error, etc.).
- Display a graphic representation of the program being executed.
- Perform a tool inspection while executing the program.

3.1 Displaying the automatic mode

When this operating mode is active, it will be indicated at the top right side of the general status bar.

This mode may be displayed with several screens. The current screen and the total number of available screens are shown at the upper right hand side of the general status bar.

Switching between the different screens is done by pressing the automatic mode accessing key. The screen selection is rotary in such a way that when pressing this key on the last screen, it shows the first one of the operating mode.

Standard configuration

The standard configuration of this work mode, described in this manual corresponds to the one supplied by Fagor. In some cases, the manual shows a sample screen, instead of that of the CNC in order to make it easier to understand.

These screens may be customized by the machine manufacturer changing its contents as well as its appearance. They may also remove certain screens or add some of their own.

3.

AUTOMATIC MODE
Displaying the automatic mode

3.1.1 Description of the screens

As mentioned earlier, the automatic mode may consist of one or several of the following screens (later sections of this chapter describe each one in further detail).

Data screen

They show execution related data: axis position, "M" and "G" function history, active tool and tool offset, spindle speed and axis feedrate.

When this screens shows a window with the program selected for execution, it will be possible to select the execution starting and ending conditions as well as to recover the program history up to a particular block.

The screenshot shows a CNC control interface titled 'EXAMPLE'. It is divided into several sections:

- Program Code:**

```

%PROGRAM
G71 G94 (T3 M6)
S1000 M3

G00 X-30 Y-30 Z10
G01 Z-10 F300
G42 X30 Y30 F650
G37 I20
X70
Y70
X30
Y30
            
```
- Axis Positions Table:**

LINE: 1	COMMAND	ACTUAL
	X 00030.000	00030.000
	Y 00050.000	00050.000
	Z 00020.000	00020.000
- Tool Parameters:**
 - M5 M41
 - G0 G17
 - T 000000001
 - D 01
 - NxTool 000000000
 - Sreal 00000
 - Sprog 00000
 - S% 100
 - Freal 00000
 - Fprog 00000
 - F% 100
 - CyTime 0:00:00.00
 - Partc 0000

Information on program execution.

Graphic screen

It shows a graphic representation of the program during execution. It also allows taking measurements on the graphics.

The screenshot shows a 3D graphical representation of a CNC program's execution. It features:

- 3D Model:** A red cylindrical part is shown above a blue stepped pyramid structure, representing the tool's path.
- Coordinates:**
 - X: -00030.000
 - Y: 00050.000
 - Z: -00020.000
 - F: 0
 - S: 0
 - T: 3
 - D: 1
- Coordinate System:** A small 3D coordinate system icon with X, Y, and Z axes is visible in the bottom right corner.

Graphic representation of the execution of the program.

3.

AUTOMATIC MODE

Displaying the automatic mode



CNC 8070

(SOFT V02.0x)

3.1.2 Description of the general status bar

The general status bar shows the following information associated with the automatic mode:

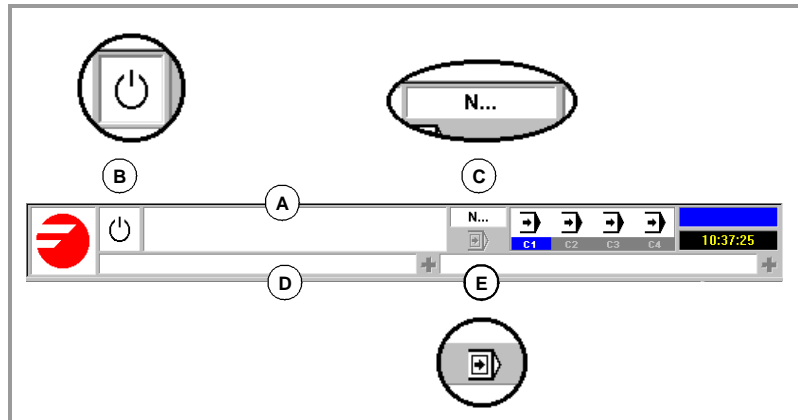

A. Program selected in the active channel for execution.

The background color of the window will be different depending on the program status.

B. Icon showing the status of the program of the active channel:

The background color will be different depending on the status of the program.



Program waiting to be executed.

Background color: White.



Program in execution.

Background color: Green.



Program interrupted.

Background color: Dark green.



Program in error.

Background color: Red.

C. Number of the block in execution.

D. Active CNC message.

For each channel, it shows the last message activated by the program that is running. The window shows the last message of the active channel. If there are messages in other channels, it will highlight the "+" sign next to the message window. To display the list of active messages, press the key combination [CTRL]+[O].

The list of messages shows, next to each message, the channel where it is active.

E. Icon that indicates that the "Single-block" execution mode is active. This execution mode is selected from the operator panel.

3.

AUTOMATIC MODE
Displaying the automatic mode

3.1.3 Channel synchronization window

The channel synchronization window is available in all work modes. This window may be expanded using the key combination [ALT]+[S]. The synchronization is carried out using marks in the programs. The window shows for each channel whether it is waiting for synchronization marks or not and the status of those marks in the channel that originates them.

The different color LED's of the window show the status of the synchronization marks of each channel. On the left, the channels waiting for the marks and on top the channels that originate them.

Led	Meaning
White	No synchronization mark expected.
Green	Synchronization mark expected. The mark is set to ·1· in the channel that originates it.
Red	Synchronization mark expected. The mark is set to ·0· in the channel that originates it.

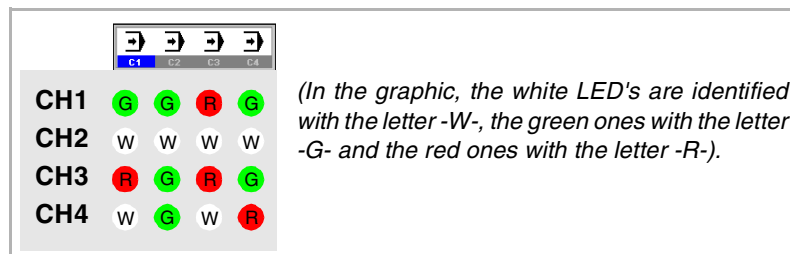

The previous graph shows for example:

- Channel 1 (CH1) is expecting synchronism marks from the rest of the channels. The marks of channels 2 and 4 are set to ·1·. The mark of channel 3 is set to ·0·.
- Channel 2 (CH2) is not expecting any synchronism mark.

3.

AUTOMATIC MODE
Displaying the automatic mode

3.1.4 Icon description (vertical softkeys)

The icon menu offers all the icons associated with this operating mode regardless of the active screen.

The icons are activated with their associated softkey (F8 to F12).

List of icons



Program selection.

It selects a program for execution.

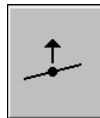

Begin tool inspection.

(This icon is only available when program execution is interrupted).

To begin tool inspection in order to check its condition.

While tool inspection is active, the axes may be jogged and the spindle may be started or stopped.

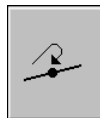

End tool inspection

(This icon is only available when tool inspection is active).

It ends tool inspection.

3.

AUTOMATIC MODE
Displaying the automatic mode

3.2 Data screen

A typical screen of the automatic mode can show the following information:

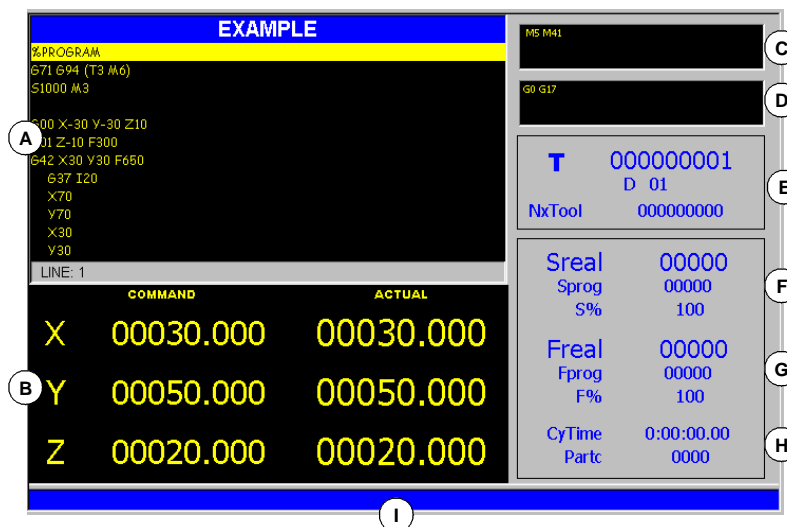

A. Program window. It shows data on the program selected for execution and lets selecting the initial and final execution blocks. It shows the following data.

- Name of the program or global subroutine, called upon from the program, that is being executed.
- Blocks of the program or subroutine being executed. During execution, the cursor shows the block being executed.

When accessing the automatic mode and after finishing the execution of the program, it shows the portion of the main program even if there are local subroutines defined in the program.

- Line of the program where the cursor is.

B. Information related to the position of the axes. In the screen configuration supplied by Fagor, the data displayed will be different on each screen. Displaying the following information is the most typical.

- The programmed coordinate, in other words, the target position.
- The current position of the axes referred to part zero or machine reference zero (home) being this position referred to the tip of the tool or to its base.
- The following error (axis lag).

C. Active "M" functions.

D. Active "G" functions and high-level commands.

E. Tool related information.

Number of the tool "T" that is currently selected, currently active tool offset "D" associated with the tool and next tool "Nextool" to be loaded into the spindle.

3.
AUTOMATIC MODE
Data screen



CNC 8070

(SOFT V02.0x)

3.

AUTOMATIC MODE
 Data screen

F. Information related to the spindle speed "S".

- "Sreal" Actual spindle speed.
- "Sprog" Programmed speed.
- "S%" Percentage of speed override being applied on to the programmed value.

Depending on the active screen, it will also show the spindle position "SPOS" and its following error "SFWE".

G. Information related to the feedrate "F" of the axes:

- "Freal" Actual feedrate of the axes.
- "Fprog" Programmed feedrate.
- "F%" Percentage of feedrate override being applied on to the programmed value.

H. Execution (cycle) time "CyTime" of the program and number of parts made "Partc".

I. CNC messages.

Softkey menus

When selecting the program screen on the softkey menus, the options associated with that window will be displayed.

The options available in the softkey menu are the following. See ["3.3 Data screen \(softkeys\)"](#) en la página 43.

- "First block"
 - To set the first block of the execution.
- "Stop condition"
 - To select the block where the execution of the program or subroutine will be interrupted.
- "Block search"
 - To recover the program history up to a particular block and resume execution from that block on.
- "Find text"
 - To find text in a program.
- "Go to line"
 - To position the cursor on a particular line of the program.



CNC 8070







(SOFT V02.0x)

3.3 Data screen (softkeys)

3.3.1 First block

It sets the block currently selected with the cursor as the first block to begin execution. When not setting the starting block, the program will begin executing from the first block.

The last block may be selected using the cursor or the "Find text" or "Go to line" options of the softkey menu.

Keys to move the cursor	
 	Moves the cursor line by line.
 	To move the cursor page by page.
 	Moves the cursor to the first block or to the end of the program.

The first block being set remains active until it is canceled (using the [ESC] key) or until the program is executed. In that case, the first block of the program will be assumed as the first block.

3.

AUTOMATIC MODE
Data screen (softkeys)



CNC 8070

(SOFT V02.0x)

3.3.2 Stop condition

To set the block where the execution of the program or subroutine will be interrupted. After executing that block, the execution may be resumed with the [START] key or canceled with the [RESET].

If the last block is not set, the program execution will end after executing one of the end of program functions "M02" or "M30".



When selecting this option, the softkey menu of the CNC shows the options available for selecting the stop condition. To return to the main menu, press the key for the previous menu.

Subroutine selection

To select the stop condition in a global subroutine which has been called upon from the program. When selecting this option, the CNC shows a list of programs available for selecting the desired subroutine.

Keys for selecting a program	
	To switch windows.
	To move the cursor thru the elements of the window.
	To open the selected subroutine.
	To cancel the selection and close the program listing.

To select a subroutine from the list.

1. Select the folder containing the subroutine.
2. Select the program containing the subroutine or write its name in the bottom window.
3. Press [ENTER] to open the program or [ESC] to cancel the selection and close the program listing.







The program window will show the contents of the selected subroutine.

Last block

It sets as execution interrupting block the one currently selected with the cursor. If the last block is not set, the program execution will end after executing one of the end of program functions "M02" or "M30".

3.
AUTOMATIC MODE
 Data screen (softkeys)

The last block may be selected using the cursor or the "Find text" or "Go to line" options of the softkey menu.

Keys to move the cursor	
 	Moves the cursor line by line.
 	To move the cursor page by page.
 	Moves the cursor to the first block or to the end of the program.

The set last block remains active until canceled (with the [ESC] key) or until the program is executed. In that case, the execution will end in one of functions "M02" or "M30".

Number of times

It sets as stop condition, that the block selected as the last block has been executed a specific number of times.

When selecting this option, the CNC requests the number of times that the block must be executed before ending the execution of the program. After entering the number of times, press [ENTER] to validate the value or [ESC] to cancel it.

3.

AUTOMATIC MODE
Data screen (softkeys)

3.3.3 Block search

3.
AUTOMATIC MODE
 Data screen (softkeys)

With this option, it is possible, in a program or subroutine, to set the last block in order to recover the program history and resume program execution from that point on with the same conditions as if it were executed from the beginning.

When recovering the program history, the CNC it reads it up to the indicated block activating the "G" and "M" functions it reads along the way. Likewise, it sets the feedrate and speed conditions in the program and calculates the position where the axes should be.



When selecting this option, the softkey menu of the CNC shows the options available for selecting the stop condition. To return to the main menu, press the key for the previous menu.

Subroutine selection

To select the stop condition in a global subroutine which has been called upon from the program.

When selecting this option, the CNC shows a list of programs available for selecting the desired subroutine.

Keys for selecting a program	
	To switch windows.
	To move the cursor thru the elements of the window.
	To open the selected subroutine.
	To cancel the selection and close the program listing.

To select a subroutine from the list.

1. Select the folder containing the subroutine.
2. Select the program containing the subroutine or write its name in the bottom window.
3. Press [ENTER] to open the program or [ESC] to cancel the selection and close the program listing.

The program window will show the contents of the selected subroutine.

Stop block







It sets as the last block for program history recovery the one currently selected with the cursor. If the program is executed next, it resumes at this block.



CNC 8070

(SOFT V02.0x)

The last block may be selected using the cursor or the "Find text" or "Go to line" options of the softkey menu.

Keys to move the cursor	
 	Moves the cursor line by line.
 	To move the cursor page by page.
 	Moves the cursor to the first block or to the end of the program.

Number of times

It sets as stop condition, that the block selected as the stop block has been executed a specific number of times.

When selecting this option, the CNC requests the number of times that the block must be executed before ending the history recovery. After entering the number of times, press [ENTER] to validate the value or [ESC] to cancel it.

If a block containing a multiple machining cycle in ISO code (G160, G161, G162, G163, G164, G165) or of the cycle editor (L MULTIPLE.CYC) has been selected as a stop block, the block search will end just before the beginning of the nth modal cycle repeated in the multiple machining.







Automatic search

With this option, it is possible to recover the program history up to the block where the execution was interrupted. The CNC remembers the block where it was interrupted; therefore, the stop block needs not be set.

Starting block

It establishes the block currently selected with the cursor as the first block of the block search. If the first block is not defined, the block search starts at the first block of the program.

The last block may be selected using the cursor or the "Find text" or "Go to line" options of the softkey menu.

Keys to move the cursor	
 	Moves the cursor line by line.
 	To move the cursor page by page.
 	Moves the cursor to the first block or to the end of the program.

3.

AUTOMATIC MODE
Data screen (softkeys)



CNC 8070

(SOFT V02.0x)

3.3.4 Find text

To find text or a character string throughout the program.

When selecting this option, the CNC shows a dialog box requesting the text to be found. It is also possible to select whether the search must start at the beginning of the program or at cursor position.

3.
AUTOMATIC MODE
 Data screen (softkeys)

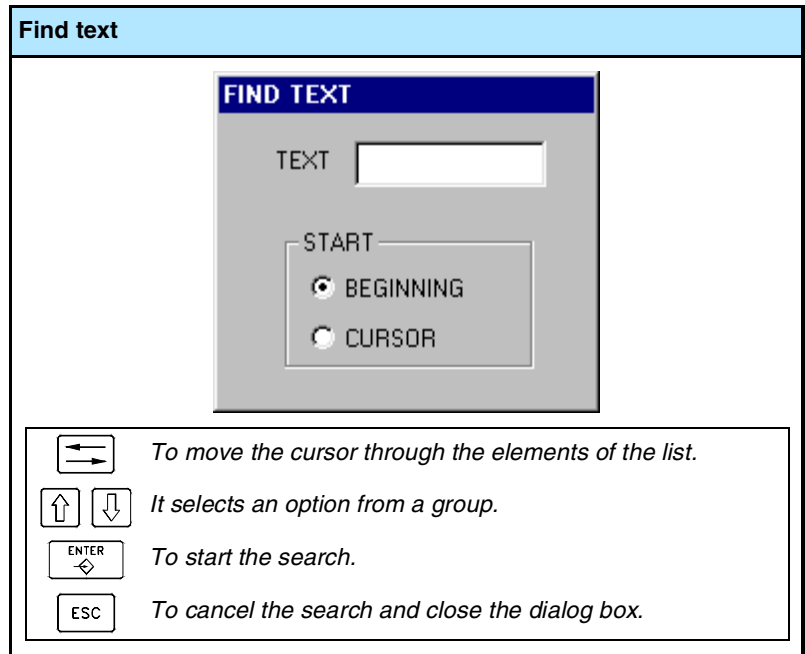

To start the search, press [ENTER] and the cursor will position on the text found. By pressing [ENTER] again, the CNC will look for the next match and so on.

To end the search, press [ESC]. The cursor will position on the block containing the text searched.

3.3.5 Go to line

To position the cursor on a particular line of the program.

When selecting this option, the CNC requests the line number. Key in the desired number and press [ENTER], the cursor will then go that line.

3.4 Graphic screen

To display a graphic representation of the program that is running and take measurements on the graphics.

Description of the graphics window

The graphic window shows the following information:

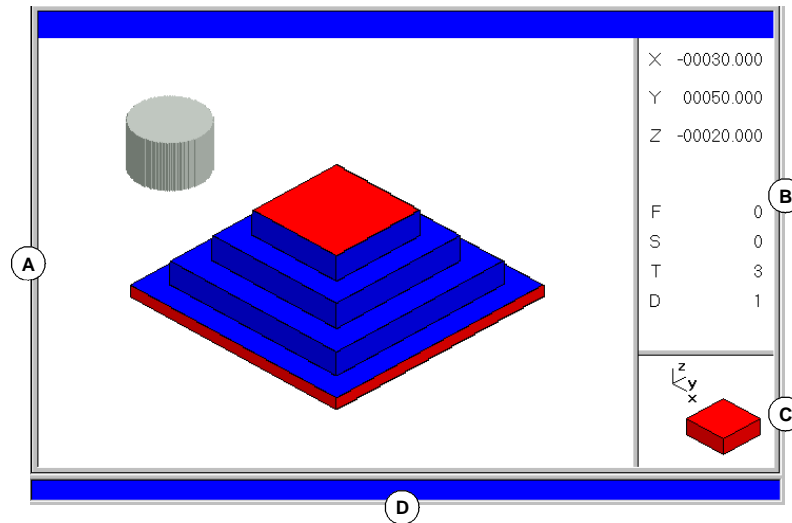

A. Display area.

Shows a graphic representation of the tool paths or of the part as the program is being executed.

B. Dialog area.







Shows the position of the axes and the machining conditions active in the execution (feedrate, spindle speed, tool and tool offset).

When selecting specific options of the softkey menu, it shows the information associated with that option which may be defined by the user.

C. Information area.

Shows the work plane appearing in the display area and an illustration representing the size of the graph and the portion of the graphic area selected with the zoom.

On 3D graphics, the illustration shows the point of view of the graph displayed and it may be changed by the operator.

Keys for selecting the point of view	
   	Select a new point of view.
	Assumes the new point of view selected.
	Cancel the selected point of view.

D. CNC messages.

3.

AUTOMATIC MODE
Graphic screen

FAGOR 

CNC 8070

(SOFT V02.0x)

Softkey menus of the graphics window

When selecting the graphic window, the horizontal softkey menu shows the options associated with that window. The set of options offered by this menu may be changed using the "+" softkey which offers a new set of options.

The options available in the softkey menu are the following. See ["3.5 Graphic screen \(softkeys\)"](#) en la página 51.

- "Type of graphics"
To select the type of graphics.
- "ZOOM"
To enlarge or reduce the whole graph shown or part of it.
- "Dimensions"
To define the size of the graphic representation.
- "Point of view"
To change the point of view of the graph and show it from another perspective.
- "Measurement"
To measure the distance between two points.
- "Clear screen"
It is used to clear the screen or delete the graphics displayed.
- "Colors"
To set the appearance of the graphics on display.
- "Options"
To set the appearance and some options of the graphic window.
- "+Real"
To display either the real or the theoretical tool path.

3.

AUTOMATIC MODE
Graphic screen

3.5 Graphic screen (softkeys)

3.5.1 Type of graphics

To select the type of graphics.

The various types of graphics may be line (3D lines, XY, XZ, YZ and Combined) or solid (Sections and 3D solid). Line graphics show the tool path with lines of different colors and solid graphics show an image of the part being executed.

The type of graphics selected will remain active until another type is selected or the graphic display is deactivated or the CNC is turned off. Likewise, when changing the type of graphics, the CNC will maintain the graphic conditions (zoom, graphic parameters, display area, etc.), defined for the last graphic.



When selecting this option, the softkey menu shows the types of graphics available. To return to the main menu, press the key for the previous menu.

"3D lines" Graphics

It displays a three-dimensional graph of the tool paths.

"Sections" Graphics

It displays a top view (XY plane) of the part being executed. It shows the machining depths in different tones. It also displays the XZ and YZ sections for the areas shown by the indicators of the top view.

These indicators may be moved around using the [↑][↓][←][→] keys, to display the different sections of the part. The CNC shows dynamically the new section being selected.

The indicators may be moved at any time even while executing the program.

"XY" - "XZ" - "YZ" graphics

It displays the tool paths in the XY, XZ or YZ plane.

"Combined" graphics

It divides the display area in four quadrants and displays the tool path corresponding to each plane XY, XZ, YZ and to the 3D view.

"Solid 3D" Graphics

It shows a 3D view of the part being machined. Starting out with a 3D block which is "machined" as the program is executed.

3.

AUTOMATIC MODE
Graphic screen (softkeys)







3.5.2 Zoom

3.

AUTOMATIC MODE
 Graphic screen (softkeys)

To enlarge or reduce the whole graph shown or part of it. This option is not available in the "Combined" type of graphics.

After selecting the zoom option, a zoom frame will appear over the graphics. This frame may be enlarged, reduced and moved around over the graphics already displayed in order to select a particular portion of it to zoom into or out of.

Keys for selecting the zoom	
   	To move the zoom frame around.
 	To change the size of the zoom frame.
	To validate and display the selected zoom area.

The graphics at the lower right-hand side of the screen shows two figures. The one shown with lines only, indicates the dimensions of the display area and the one with colored sides indicates the portion selected with the zoom.



When selecting this option, the softkey menu shows the available zoom options. To return to the main menu, press the key for the previous menu.

Zoom "Initial"

Restores the size of the display area set via program or using the "Dimensions" option.

Zoom "Automatic"

The CNC uses the zoom that it considers best according to the movements programmed.

Zoom "Previous"

It displays up to two zooms defined earlier. After the second one, it shows again the one defined last.

Zoom "Limits"

Only for the "Sections" type. In this graphics, zooming is done by moving the indicators that appear framing the graphic sections.

With this option, it is possible to select the axis whose indicator is to be moved.

The indicator may also be selected with the "+" and "-" keys of the numeric keyboard in a rotary fashion (Xmin, Xmax, Ymin, Ymax, Zmin, Zmax).







CNC 8070

(SOFT V02.0x)

Zoom "Edit"

It is used to manually edit the zoom values. It is edited in the dialog area of the graphic window that shows the dimensions of the zoom frame

Keys for defining the zoom	
 	To move the cursor through the data.
	To validate and display the defined zoom area.
	To cancel the defined zoom.

3.

AUTOMATIC MODE
Graphic screen (softkeys)

FAGOR 

CNC 8070

(SOFT V02.0x)

3.5.3 Dimensions

It is used to define the size of the graphic representation by setting the maximum and minimum coordinates of the graphics on each axis.







When selecting this option, the softkey menu shows the options available for setting the dimensions. To return to the main menu, press the key for the previous menu.

Dimensions "Automatic"

The CNC sets the dimensions that it considers best according to the movements programmed.

Dimensions "Edit"

It is used to manually edit the dimension values. It is edited in the graphic window that shows the dimensions of the graphics on each axis.







Keys for setting the dimensions	
 	To move the cursor through the data.
	To validate and display the set dimensions.
	To cancel the set dimensions.

3.
AUTOMATIC MODE
 Graphic screen (softkeys)

3.5.4 Point of view

It is used to select the point of view on 3D graphics.

The orientation of the graphics may be directly selected at the graphic window by orienting the XY plane and the Z axis. The XY plane may be rotated 360° and the Z axis 90°. The figure at the lower right-hand side of the screen shows the point of view currently selected.





Keys for selecting the point of view	
 	To orient the XY plane.
 	To orient the Z axis.
	To validate and display the selected point of view.
	To cancel the selected point of view.



When selecting this option, the softkey menu shows the options available for selecting the point of view. To return to the main menu, press the key for the previous menu.

Point of view "Edit"

It is used to manually edit the orientation of the axes of the graphics. It is edited in the dialog area of the graphic window that shows the current orientation of the axes.

Keys for defining the point of view	
 	To move the cursor through the data.
	To validate and display the defined point of view.
	To cancel the defined point of view.





3.

AUTOMATIC MODE
Graphic screen (softkeys)

3.5.5 Measurement

To measure the distance between two points. This option is only available for the types of graphics "XY", "XZ", "YZ" and "Solid 3D".

When selecting this option, the section being measured will appear on the graphics with two cursors and a dashed line. The cursor currently selected will appear in red.

Keys to move the cursors	
	<i>To move the selected cursor.</i>
	
	
	<i>To select the cursor to be moved.</i>
	

The dialog area will show the coordinates of both cursors, the distance between them on the straight line and the components of that distance on the axes of the active plane. The coordinates of the selected cursor will appear in red.





When selecting this option, the softkey menu shows the available options. To return to the main menu, press the key for the previous menu.

Measurement "Point1" & "Point2"

It is used to select the cursor to be moved (same as using the "+" key).

Measurement "Edit"

It is used to manually edit the position of the cursors. It is edited in the dialog area of the graphic window that shows the position of both cursors.

Keys for defining the measurement	
	<i>To move the cursor through the data.</i>
	
	<i>To validate the selected position of the cursors.</i>

3.5.6 Clear screen

It is used to clear the screen or delete the graphics displayed.

If a solid graphic type is selected, the graphic representation will be reset and it will return to its initial state without machining.

3.
AUTOMATIC MODE
 Graphic screen (softkeys)



CNC 8070

(SOFT V02.0x)

3.5.7 Colors

It is used to change the colors used in the graphic representation.

- Path colors. When a line graphics is active, the following colors may be defined:

- The color to draw the rapid traverse.
- The color to draw the canned cycles.
- The color to draw the compensated path.
- The color to draw the theoretical path.
- The color to draw the threading.
- The color to represent the real coordinates. The real coordinate is the actual position of the tool which differs from the command coordinate in the amount of following error (axis lag).
- The background color of the window.

- Colors for solids. When a solid graphics is active, the following colors may be defined:

- The color to draw the outside X.
- The color to draw the inside X.
- The color to draw the outside Y.
- The color to draw the inside Y.
- The color to draw the outside Z.
- The color to draw the inside Z.
- The background color of the window.











When selecting this option, the softkey menu shows the available options. To return to the main menu, press the key for the previous menu.

Colors "Apply"

It assumes the new colors and applies them to the blocks drawn next. If the new colors are not applied, the graphics are drawn with the old colors.

Colors "Edit"

It is used to select the new colors for the graphics. They are selected in the dialog area of the graphic window that show the current colors.

Keys for defining colors	
 	To move the cursor through the data.
	To open and close the color palettes.
	To move the cursor through the colors of the palette.
  	
	To cancel the selected colors.

3.

AUTOMATIC MODE
Graphic screen (softkeys)



CNC 8070

(SOFT V02.0x)

3.5.8 Options

It is used to set the appearance and some functions of the graphic window. These options may be used at any time, even while executing a program.



When selecting this option, the softkey menu shows the available options. To return to the main menu, press the key for the previous menu.

Option "Activate" / "Deactivate"

It is used to activate or deactivate the graphic representation.

When the graphic representation is deactivated and activated, the current graphic is erased; but the display conditions are kept active (type of graphics, zoom, graphic parameters and display area) that were active before that mode was deactivated.

Option "Simple" / "Combined"

It is used to hide or show the dialog and data areas on the right-hand side of the graphic window so the drawing occupies the whole graphic window.

Option "Hide Tool" / "Show Tool"

It is used to hide or show the tool while executing in "3D solid" graphics.

Option "Print"

It is used to print the graphics in a printer connected to the CNC or as a file (BMP format) at the CNC. When printing to a file, it is saved in the folder:

"C:\Cnc8070\Users\Reports*.bmp"

When selecting this option, the CNC will show a dialog box requesting the print destination (printer or file).

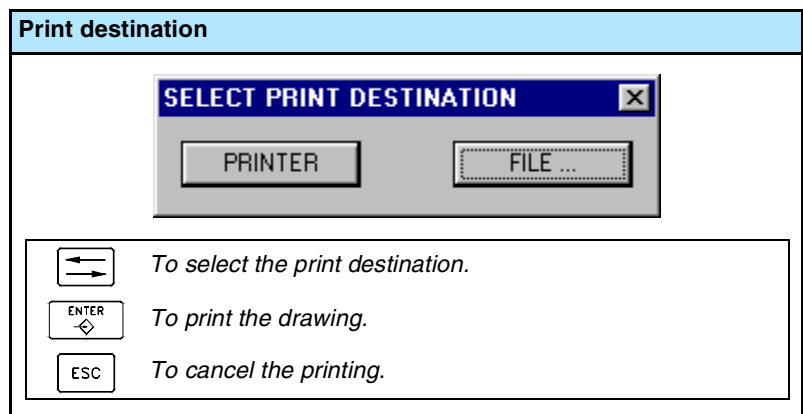

After selecting the destination, press [ENTER] to print it or [ESC] to cancel it.

3.
AUTOMATIC MODE
 Graphic screen (softkeys)



CNC 8070

(SOFT V02.0x)

Option "Print setup"

It is used to set the printing configuration.

When selecting this option, the CNC shows a dialog box where the following may be defined:

- A. The title of the graphics that will appear next to it in the print.
- B. The name of the file where the graphics will be stored when printing out to a file.

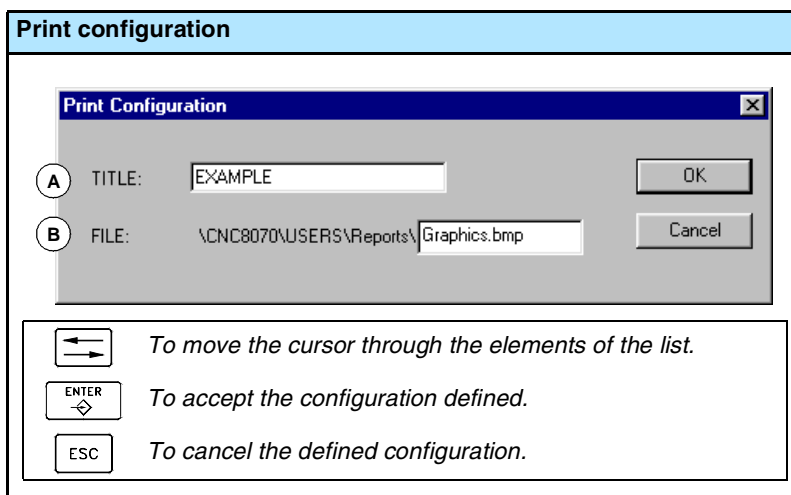

After filling out the data, press [ENTER] to accept them or [ESC] to cancel them.

3.5.9 Real coordinates

It is used to draw the real tool path or the theoretical tool path. This option is only available in line type graphics.

When selecting this option (the softkey will appear pressed), the CNC draws the actual (real) tool path.

3.

AUTOMATIC MODE
Graphic screen (softkeys)

3.6 Program selection and execution

3.6.1 Program selection

A different program may be selected and executed in each channel. The program is executed in the channel where it is selected from.



To select a program, press the icon "Select program" of the softkey menu and the CNC will show a list of all the programs available. See ["2.5 File selection window"](#) en la página 24.

Once a program has been selected, its name appears on the general status bar. For each channel, it shows the name of the program selected in that channel.

3.

AUTOMATIC MODE
Program selection and execution

3.6.2 Program execution

The name of the program selected in the channel for execution appears on the general status bar. See "[3.1.2 Description of the general status bar](#)" en la página 38.

If not indicated otherwise, the program execution will begin from the first block of the program to the execution of one of the end-of-program functions "M02" or "M30". As an option, it is possible to define the first and last blocks of the execution. See "[3.3 Data screen \(softkeys\)](#)" en la página 43.

Start executing

To start the execution of the program, press [START] on the Operator Panel.

The program may be executed in –single block– or –automatic– mode. The mode may be selected even while executing the program. When –single block– is active, the screen will display the relevant symbol on the general status bar.

If the –single block– mode is active, program execution will be interrupted at the end of each block; the [START] key must be pressed again to execute the next block. If the –automatic– mode is active, the program will be executed all the way to the end or up to the block selected as end of execution.

Interrupting the execution

The [STOP] key interrupts the execution of the program. Press [START] again to resume execution from where it was interrupted.

The execution may be interrupted at any time, except when threading. In that case, it will be interrupted at the end of the threading operation.

Stop the execution

The [RESET] key cancels the execution of the program and resets the CNC to its initial conditions.



The program selected for execution may be executed in any operating mode by pressing [START] on the Operator Panel. The CNC will request confirmation before starting to execute the program.

3.

AUTOMATIC MODE

Program selection and execution

3.6.3 Tool inspection

3.

AUTOMATIC MODE
 Program selection and execution

This option is only available when the running program has been interrupted. Activating tool inspection makes the following operations possible:

- Jogging the axes using the JOG keys of the operator panel or handwheels.
- Stop and start the spindle using the keys on the operator panel.
- Access the CNC tables (tools, tool offsets, etc.) and modify their data.

Once tool inspection is completed and before resuming the execution of the program, the spindle must be started and the axes repositioned to the point where tool inspection began. Once the axes are repositioned, press [START] to resume program execution.

Reposition the axes and the spindle



To end tool inspection and reposition the spindle and the axes at the point where tool inspection began, press the relevant icon.

After pressing this icon, the CNC will show a list of the axes that are out of position. If the spindle was stopped during tool inspection, next to the list of axes, it will also show the status that the spindle had before the inspection.

The axes and the spindle may be repositioned simultaneously.

Reposition the axes.

The axes may be repositioned one by one or all at the same time. To reposition them, select the axes with the relevant softkey and press [START]. The axes reposition at the feedrate defined by the OEM.

The axes may be repositioned using the JOG keys or handwheels. On the other hand, repositioning may be interrupted (using the [STOP] key) to select other axes. Once one axis has reached its position, it will no longer be available.

Restore the spindle turning direction.

The spindle turning direction may be restored together with the axes or separately. To do this, it shows, next to the axes to be repositioned, the previous status of the spindle (M3, M4 or M19). To restore the turning direction, select the softkey and press [START].

3.6.4 Block search and program execution

With block search, it is possible to recover the program history up to a particular block in such way that if program execution is resumed at that block, it will do so with the same conditions as if it were executed from the beginning.

There are two types of block search:

- Automatic

To recover the program history up to the block where the execution was canceled. The CNC remembers the block where interruption was canceled, thus not being necessary to set the stop block.
- Manual

To recover the program history up to a particular block set by the operator.

When recovering the program history, the CNC it reads it up to the indicated block activating the "G" and "M" functions it reads along the way. Likewise, it sets the feedrate and spindle speed conditions of the program and calculates the position where the axes should be.

To recover the program history, proceed as follows:

1. To do an automatic search, i.e. restore the history up to the point where the program was interrupted, press "Automatic Search". The search starting point may be chosen by selecting the first block.
2. For a manual search, set the last point using the stop block, select the subroutine (optional) and the number of times (optional). The search starting point may be chosen by selecting the first block.
3. Press [START] to recover the program history.

The CNC will set the feedrate and speed conditions of the program and will start the spindle in the set direction ("M3" or "M4"). It will also activate the "M" and "G" functions defined in the program.
4. Reposition the axes to the position to resume execution.
5. Press [START] to execute the program.

Reposition the axes.



To reposition the axes, press the corresponding icon and the CNC will show the axes that are out of position.

The axes may be repositioned individually or several at the same time in one of the following ways:

- Manually

Jog the axes with the handwheels or with the JOG keys. The movement is limited by the repositioning end point and the corresponding software limit.

3.

AUTOMATIC MODE

Program selection and execution

3.

AUTOMATIC MODE

Program selection and execution

- Automatically

Select the axes with the relevant softkey and press [START]. Repositioning may be interrupted (using the [STOP] key) to select other axes.

When an axis reaches the repositioning end point, it is no longer available; however, this axis may be moved with the handwheel or the JOG keys under the same conditions as before. Once all the axes have been repositioned, none of them may be moved.

▼ Jog (manual) mode selection



The manual (JOG) mode may be accessed from any other operating mode, except when a program is in execution, by pressing its relevant key.

In the same channel, the jog mode cannot be accessed while a program is running or a block is being executed in MDI. The jog mode may be accessed in the rest of the channels.

If the execution of the program has been interrupted, the CNC will cancel the execution of the program and will go into jog mode. A program is interrupted when the [STOP] has been pressed or is waiting in single-block mode.

When accessing the jog mode from the automatic mode, the CNC keeps the machining conditions selected in the last mode.

▼ Operations in this work mode

The following operations are possible in this work mode:

- Display various data related to axes position.
(Position referred to part zero or to home, following error, etc.).
- Home the axes (Machine reference zero search).
- Jog the axes using the keys on the operator panel or electronic handwheels.
- Move an axis to a position by previously selecting the target point.
- Preset a coordinate.
- Start and stop the spindle manually using the keys of the operator panel.
- Change tools.
- Activate up to 16 external devices using the keys of the upper side of the operator panel. The external devices associated with each key must be defined by the machine manufacturer.
- Calibrate a tool in jog mode (without probe), in semi-automatic mode (when using a table-top probe) or using the tool calibration cycle (also when using a table-top probe).

4.1 Appearance of the Manual (JOG) mode

This mode may be displayed with several screens. The current screen and the total number of available screens are shown at the upper right hand side of the general status bar.

Switching between the different screens is done by pressing the jog mode accessing key. The screen selection is rotary in such a way that when pressing this key on the last screen, it shows the first one of the operating mode.

Standard configuration

The standard configuration of this work mode, described in this manual corresponds to the one supplied by Fagor. In some cases, the manual shows a sample screen, instead of that of the CNC in order to make it easier to understand.

These screens may be customized by the machine manufacturer changing its contents as well as its appearance. They may also remove certain screens or add some of their own.

4.

MANUAL (JOG) MODE

Appearance of the Manual (JOG) mode



CNC 8070

(SOFT V02.0x)

4.1.1 Description of a typical screen of this work mode

A typical screen of the jog mode can show the following information:

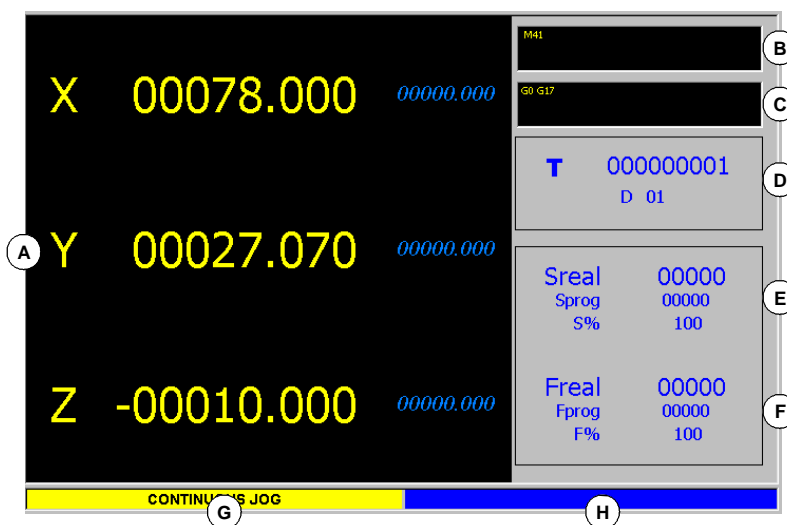

A. Information related to the position of the axes. In the screen configuration supplied by Fagor, the data displayed will be different on each screen.

The most common thing is to show the current position of the axes referred to part zero in large characters, and the amount of following error (axis lag) in small characters.

Another more detailed option shows the coordinates of the tool tip and those of the tool base, being both referred to part zero and machine zero.

B. Active "M" functions.

C. Active "G" functions and high-level commands.

D. Tool related information.

Tool number "T" currently selected and active tool offset "D" associated with the tool.

E. Information related to the spindle speed "S".

"Sreal" Actual spindle speed.

"Sprog" Programmed speed.

"S%" Percentage of speed override being applied on to the programmed value.

Depending on the active screen, it will also show the spindle position "SPOS" and its following error "SFWE".

F. Information related to the feedrate "F" of the axes:

"Freal" Actual feedrate of the axes.

"Fprog" Programmed feedrate.

"F%" Percentage of feedrate override being applied on to the programmed value.

G. Moving mode selected at the jog selector switch on the operator panel.

H. Reserved.

4.

MANUAL (JOG) MODE
Appearance of the Manual (JOG) mode

4.1.2 Vertical softkey menu (icons)

4.

MANUAL (JOG) MODE
 Appearance of the Manual (JOG) mode



Display units (millimeters/inches).

It is used to change the units for displaying the position (coordinates) of the linear axes and the feedrate data. Toggling these units does not affect the rotary axes which will always be displayed in degrees.

The icon highlights the units currently selected (millimeters or inches).

It must be borne in mind that the units can only be changed on the data display. A program assumes the units defined with the active function "G70" or "G71", or, when not programmed, the units set by the machine manufacturer.

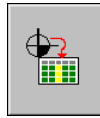

Load zero offset or fixture offset tables.

It may be used to save the active zero offset in the zero offset or fixture offset table.

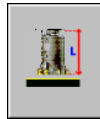

Tool calibration.

It accesses the tool calibration screens.

4.2 Operations with the axes

4.2.1 Home search

It is the operation used to synchronize the system. This operation must be carried out when the CNC loses the position of the origin point (e.g. by turning the machine off).

When "searching home", the axes move to the machine reference point and the CNC assumes the coordinate values assigned to that point by the machine manufacturer, referred to machine zero. When using distance-coded reference marks or absolute feedback, the axes will only move the distance necessary to verify their position.

The axes may be homed manually or automatically.

- Manual homing is done one axis at a time, from the operator panel.
- Automatic homing is done with a subroutine defined by the machine manufacturer.

Manual home search

It is done one axis at a time. Home search of an axis is carried out as follows:



1. Select the axis to be homed using the alphanumeric keyboard. The CNC will highlight that axis to indicate that it is selected.

To select the numbered axes (e.g. "X1"), select any axis and then move the selection until positioning on the desired one. The focus moves with the [↑][↓] keys.



2. Press the homing key [ZERO]. The CNC will display the "1" symbol in the numeric area indicating that a home search will take place.



3. Press [START] to go ahead with the home search or [ESC] to cancel the operation.



When searching home in this mode, the CNC cancels the zero offset, the fixture offset and the measuring offset. It assumes the machine reference zero point (home) as the new part zero.

4.

MANUAL (JOG) MODE
Operations with the axes

Automatic home search

This homing method is only available if the machine manufacturer has previously defined a homing subroutine.

Home search using a subroutine is carried out as follows:

1. Press the homing key [ZERO]. The CNC will display a dialog box requesting confirmation to execute the home search.
2. Press [START] to go ahead with the home search or [ESC] to cancel the operation.



4.

MANUAL (JOG) MODE
Operations with the axes

4.2.2 Jogging the axes

The axes may be jog using the JOG keyboard on the operator panel. Two types of movements may be made.

- Continuous jog, when the axis moves while acting on the keyboard.
- Incremental jog, when the axis moves a specific distance every time the operator acts on the keyboard.

The type of jog is selected with the jog selector switch on the operator panel.



Continuous jog



Incremental jog



Handwheels

JOG keys

There are two types of jog keyboards depending on the behavior of the keys.

Type I

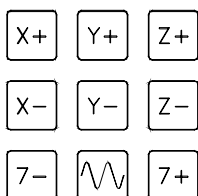

There are two keys for each axis. One to jog the axis in the positive direction and another one to move it in the negative direction.

To move a single axis, press the axis key and the one for its jogging direction.

Type II

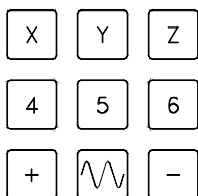

There is a key for each axis and two keys for moving direction, common to all the axes.

To jog an axis requires activating both the axis key and the moving direction. There are two options, depending on how the jog keyboard has been configured.

- The axis will move while both keys are pressed, the axis key and the direction key.
- When pressing the axis key, the key remains active. The axis will move while the direction key is kept pressed. To de-select the axis, press [ESC] or [STOP].

Feedrates

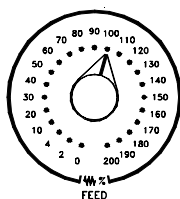

The movement is carried out at the feedrate defined by the OEM. The feedrate may be varied between 0% and 200% using the feedrate override switch on the operator panel.

4.

MANUAL (JOG) MODE
Operations with the axes

FAGOR

CNC 8070

(SOFT V02.0x)

Continuous JOG

In continuous jog, the axes keep moving while the jog keyboard is acted upon. Continuous jog allows moving several axes at the same time.

Proceed as follows:

1. Turn the jog selector switch^(a) of the operator panel to the continuous jog position on the dial.
2. Jog the desired axis using the JOG panel (keypad). The axis will move while acting upon the JOG panel.

If while moving, a second axis is selected, the new one will move at the same time and under the same conditions.

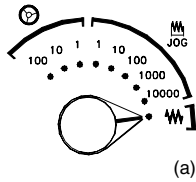

If while the axes are moving, the rapid key is pressed, the axes will move at the rapid rate set by the machine manufacturer. This feedrate will be applied while that key is kept pressed and, when released, the axes will recover their previous feedrate. This rapid rate may be varied between 0% and 200% with the feedrate override switch on the operator panel.

Incremental JOG

In incremental jog, the axis moves a specific distance every time the key is pressed. In incremental jog, the axes may be jogged simultaneously.

Proceed as follows:

1. Turn the jog selector switch of the operator panel to one of the incremental jog positions. Each position will move the axis a fixed distance; the typical values are the following.

Selector position	Distance
1	0.001 mm or 0.0001 inches
10	0.010 mm or 0.0010 inches.
100	0.100 mm or 0.0100 inches.
1000	1.000 mm or 0.1000 inches.
10000	10.000 mm or 1.0000 inches.

2. Jog the desired axis using the JOG panel (keypad). Every time the JOG panel is acted upon, the axis will move the distance indicated on the dial of the jog selector switch.

If while moving, a second axis is selected, the new one will move at the same time and under the same conditions.

4.
MANUAL (JOG) MODE
 Operations with the axes



CNC 8070

(SOFT V02.0x)

4.2.3 Jogging the axes with handwheels

Up to three electronic handwheels may be used to move the axes.

Depending on configuration, there may be a general handwheel to move any axis or an individual handwheel per axis that will only move its associated axis.

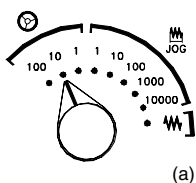

To move the axes with the handwheels, turn the jog selector switch^(a) of the operator panel to one of the handwheel positions. Every position indicates the multiplying factor applied to the handwheel pulses; the typical values are the following.

Selector position	Distance
1	0.100 mm or 0.0100 inches.
10	1.000 mm or 0.1000 inches.
100	10.000 mm or 1.0000 inches.

Once the desired resolution has been selected and depending on the type of handwheel being used, general or individual, proceed as follows.

General handwheel

The general handwheel is not associated with any axis in particular. It may be used to move any axis of the machine (if the manufacturer has set it that way).

Proceed as follows.

1. Select the axis to be jogged.

On the JOG keyboard, press one of the keys for the axis to be jogged. If several axes are selected simultaneously, they all move at the same time.

The CNC will highlight them, indicating that they are selected. When selecting an axis or quitting the handwheel mode using the movement selector, the previous one is automatically deselected.
2. Once the axis has been selected, the CNC will move it as the handwheel is turned depending on the setting of the selector switch and on the turning direction of the handwheel.

The feedrate depends on how fast the handwheel is turned.

4.

MANUAL (JOG) MODE
Operations with the axes

Individual handwheel

The individual handwheel is associated with a particular axis. The CNC moves each axis as its relevant handwheel is turned depending on the setting of the selector switch and on the turning direction of the handwheel.

When moving several axes simultaneously using handwheels, all the axes having their own handwheel plus another one selected with the general handwheel may be involved.

When moving several axes at the same time, the feedrate of each axis depends on how fast its associated handwheel is turned.



It may happen that depending on the turning speed and the selector position, the CNC be demanded a faster feedrate than the maximum allowed. In that case, the CNC will move the axis the indicated distance but at the maximum feedrate allowed.

4.

MANUAL (JOG) MODE

Operations with the axes

4.2.4 Moving an axis to a particular position (coordinate)

When moving the axes to a specific position, they must do so one by one following these steps:



1. Select the axis to be homed using the alphanumeric keyboard. The CNC will highlight that axis to indicate that it is selected.

To select the numbered axes (e.g. "X1"), select any axis and then move the selection until positioning on the desired one. The focus moves with the [↑][↓] keys.

2. Enter the coordinate of the target point.
3. Press [START] to execute the movement or [ESC] to cancel the operation.

Feedrate behavior

The moving feedrate depends on whether G00 or G01 is active.

- If G00 is active, the movement is carried out at the rapid rate defined by the machine manufacturer.
- If G01 is active, the movement is carried out at the active feedrate. If no feedrate is active, the movement is executed at the feedrate defined by the machine manufacturer.

This feedrate may be varied between 0% and 200% using the feedrate override switch^(a) on the operator panel. The percentage will be applied on to all the movements carried out in G00 and in G01.

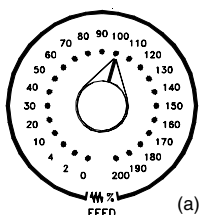

(a)

4.

MANUAL (JOG) MODE
Operations with the axes

4.2.5 Coordinate preset



Coordinates must be preset axis by axis following these steps:

1. Select the axis to be homed using the alphanumeric keyboard. The CNC will highlight that axis to indicate that it is selected.

To select the numbered axes (e.g. "X1"), select any axis and then move the selection until positioning on the desired one. The focus moves with the [↑][↓] keys.

2. Key in the desired preset value.
3. Press [START] to preset the entered value or [ESC] to cancel the operation.

The preset may be canceled by homing the axes one by one or by means of function "G53".

4.

MANUAL (JOG) MODE
Operations with the axes

4.3 Spindle control

The spindle may be controlled manually using the following keys of the operator panel. The keys always refer to the master spindle of the active channel.

The spindle speed should be set (in the MDI mode) before selecting the turning direction, thus avoiding a sudden start of the spindle when setting an "S" because the turning direction was active.

Starts the spindle clockwise. Same as function M03.



Starts the spindle clockwise at the active speed.

Displays function M03 in the history of the current machining conditions.

Start the spindle counterclockwise. Same as function M04.



Starts the spindle counterclockwise at the active speed.

Displays function M04 in the history of the current machining conditions.

To stop the spindle. Same as function M05.



To stop the spindle.

Displays function M05 in the history of the current machining conditions.

Spindle speed override.



It may be used to vary the spindle turning speed, a typical value being a variation between 50% and 120%. Every time one of these keys is pressed, the speed varies 5%.

These values may be different depending on how the machine manufacturer has defined them.

Spindle orientation. Same as function M19.



It orients the spindle.

Displays function M19 in the history of the current machining conditions.

Customizing the keys

The machine manufacturer sets the minimum and maximum percentages between which the speed may be varied as well as the percentage of variation every time one of these keys is pressed.

They are set using the following machine parameters.

MINOVR	Minimum override.
MAXOVR	Maximum override.
STEPOVR	Override increment (step).

4.

MANUAL (JOG) MODE
Spindle control

4.4 Tool selection and tool change

The tool located in the spindle may be changed in manual mode. Proceed as follows.

1. Press [T] at the alphanumeric keyboard. The CNC will highlight the current tool indicating that it is selected.
2. Key in the number of the tool to be placed in the spindle.
3. Press [START] to execute the tool change or [ESC] to cancel the operation.

4.

MANUAL (JOG) MODE

Tool selection and tool change



CNC 8070

(SOFT V02.0x)

4.5 Definition of cutting conditions

In jog mode, it is possible to set the turning speed "S" and the feedrate "F".

- The feedrate will correspond to the active feedrate.
- The speed entered will correspond to the master spindle of the active channel.

Proceed as follows.

1. Press the [S] key on the alphanumeric keypad to select a spindle speed or the [F] key to select a feedrate. The CNC will highlight the relevant data indicating that it is selected.
2. Enter the desired spindle speed or feedrate.
3. Press [START] to assume the entered value or [ESC] to cancel the operation.

4.

MANUAL (JOG) MODE
Definition of cutting conditions

FAGOR 

CNC 8070

(SOFT V02.0x)

4.6 Automatic loading of zero offsets or fixture offset tables

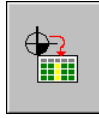

It may be used to save the active zero offset in the zero offset or fixture offset table. This operation is carried out using the "Load table" icon.

Proceed as follows:

1. Press the icon for "Load table". The CNC shows the list of available zero offsets and fixture offsets.
2. Select the zero offset or fixture offset where you wish to save the active offset.
3. Press [ENTER] to enter the offset in the table.

The [ESC] key cancels the operation at any time.

4.

MANUAL (JOG) MODE

Automatic loading of zero offsets or fixture offset tables

4.7 Tool calibration



The tools may be calibrated in jog mode. This operation is carried out using the "Tool calibration" icon.

- When not using a tabletop probe, when pressing the "Calibration" icon, it accesses the probeless tool calibration mode (manual calibration).
- When not using a tabletop probe, when pressing the "Calibration" icon, it accesses the "tool calibration with probe" mode (semi-automatic calibration). From this mode, it is possible to access the calibration and measuring mode using the cycle designed for that purpose (automatic calibration).



(a)

The various calibration modes may be selected using the screen-change key^(a)

To quit the calibration mode and return to jog mode, press the [ESC] key.

4.

MANUAL (JOG) MODE

Tool calibration

4.7.1 Tool calibration without a probe

It may be used to calibrate the length of the tool that is currently at the spindle. It is also possible to change the tool that is in the spindle or insert a tool if the spindle is empty.

To select a new tool or tool offset, proceed as follows:

For a new tool: [T] + <number> + [START].

For a new tool offset: [D] + <number> + [START].

After the calibration, the length wear is reset to zero. The radius and radius wear may be set manually.

When changing the tool data, the tool table data is updated after calibration.

4.
MANUAL (JOG) MODE
Tool calibration

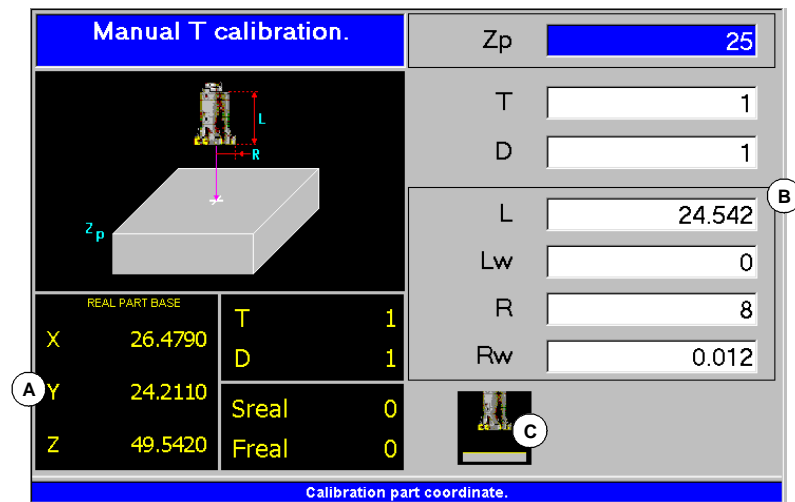

A. Information area.

Tool position, tool selected at the spindle and active offset, speed and feedrate.

B. Data definition area.

C. Calibration allowed.

Softkey menu (icons)

When accessing the probeless calibration mode, the icon menu shows the following options:



CNC 8070



Display units (millimeters/inches)

It is used to change the units to display coordinates.

The icon highlights the units currently selected (millimeters or inches).

Validating the calibration

It validates the calibration. It updates the length value and resets the wear value to zero.

(SOFT V02.0x)

▼ Data definition

Place the cursor over the relevant data, key in the desired value and press [ENTER].

Zp	Coordinate of the calibration part.
T	Tool.
D	Tool offset.
L	Tool length.
Lw	Length wear.
R	Tool radius.
Rw	Radius wear.

▼ Calibrate the tool

The radius must be defined directly. To calibrate the length, follow these steps:

1. Define the Z coordinate of the part used for calibration.
2. Select the tool and the offset. For calibration, the tool must be inserted in the spindle.
 - If you select a tool and press [ENTER], the CNC shows the dimensions defined for that offset in the tool table.
 - If you select a tool and press [START], the CNC inserts the tool into the spindle and shows the dimensions defined for that offset in the tool table.
3. Calibrate the tool. Approach the tool manually until touching the part and press the "Validate the calibration" icon.

It updates the length value and resets the wear value to zero. The data is stored in the tool table.

To calibrate another tool, repeat steps 2 and 3.

4.

MANUAL (JOG) MODE
Tool calibration

4.7.2 Tool calibration with a probe

This option is only available when using a tabletop probe installed on the machine. If it is not available, see section ["4.7.1 Tool calibration without a probe"](#)

It may be used to calibrate the length or the radius of the tool that is currently in the spindle. After the calibration, the wear is reset to zero.

When changing the tool data, the tool table data is updated after calibration.

4.

MANUAL (JOG) MODE
Tool calibration

T calibration with a probe

PRBMOVE	25
F	200
T	2
D	1
L	20
Lw	0
R	2
Rw	0

REAL MACHINE BASE	
X	71.5760
Y	8.7350
Z	19.7250

T	2
D	1
Sreal	200
Freal	0

To measure:
Place T at probing starting point.
Select axis and probing direction. Press START.

Probing feedrate.

- A. Information area.
- B. Data definition area.

Softkey menu (icons)

When accessing the probeless calibration mode, the icon menu shows the following options:



Display units (millimeters/inches)

It is used to change the units to display coordinates.

The icon highlights the units currently selected (millimeters or inches).

T measuring cycle

It accesses the mode for tool calibration and tool wear measurement using the "#PROBE 1" canned cycle. See ["4.7.3 Calibration and wear measurement with probe"](#) en la página 86.



CNC 8070

(SOFT V02.0x)

Data definition

Place the cursor over the relevant data, key in the desired value and press [ENTER].

PRBMOVE	Maximum probing distance. If the CNC does not receive the probe signal before reaching moving this probing distance, it stops the axes.
F	Probing feedrate.
T	Tool.
D	Tool offset.
L	Tool length.
Lw	Length wear.
R	Tool radius.
Rw	Radius wear.

Calibrate the tool

To calibrate the tool, follow these steps:

1. Define the probing distance and feedrate.

If the feedrate is not defined, the probing movement will be made at the feedrate set by the OEM.

2. Select the tool and the offset. For calibration, the tool must be inserted in the spindle.

- If you select a tool and press [ENTER], the CNC shows the dimensions defined for that offset in the tool table.
- If you select a tool and press [START], the CNC inserts the tool into the spindle and shows the dimensions defined for that offset in the tool table.

3. Calibrate the tool. Select the axis and the probing direction on the softkey menu and press [START].

The probe moves along the selected axis and direction until touching the probe. It updates the measured value and resets the wear value to zero. The data is stored in the tool table.

To calibrate another tool, repeat steps 2 and 3.

4.

MANUAL (JOG) MODE
Tool calibration

FAGOR 

CNC 8070

(SOFT V02.0x)

4.7.3 Calibration and wear measurement with probe

This option is only available when using a tabletop probe installed on the machine. If it is not available, see section "4.7.1 Tool calibration without a probe"

This option may be used to calibrate the length, the radius and measure the wear of the tool currently in the spindle.

The tool table data is updated once the operation is finished.

The desired operation is selected from the softkey menu. Only the data needed to define the selected operation will be accessible on the screen.

- L Calibrate the length.
- R Calibrate the radius
- L-R Calibrate the length and the radius.
- LW Measure the length wear.
- RW Measure the radius wear.
- LW-RW Measure the length and radius wear.
- XYZ FSTD It hides the help graphics and shows the information about the machine (coordinates, feedrate, spindle speed, etc.)

4.
MANUAL (JOG) MODE
Tool calibration

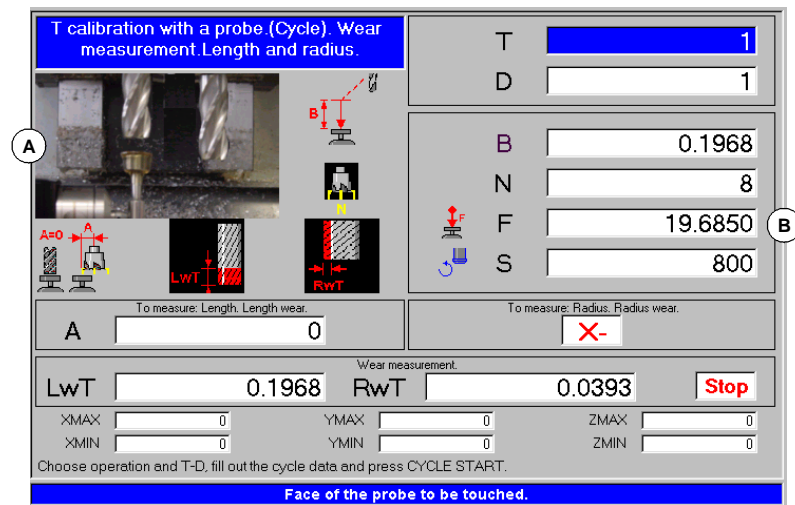

- A. Help graphics or information about the machine
- B. Data definition area.



CNC 8070

(SOFT V02.0x)

▼ Icon menu

When accessing the calibration and measurement mode, the icon menu shows the following options:



Display units (millimeters/inches)

It is used to change the units to display coordinates.

The icon highlights the units currently selected (millimeters or inches).

Probe position

It allows defining the operation with certain probe position data other than the ones defined in the machine parameters.

Reset values

It resets the data to its default values.

▼ Data definition

To define the numerical data, place the cursor over the relevant data, key in the desired value and press [ENTER].

The reset of the data are defined from the icon menu.

T	Tool.
D	Tool offset.
B	Safety distance.
N	Number of edges to measure. If programmed with a "0" value, it only measures once.
F	Probing feedrate.
S	Spindle speed.
A	Radius or distance referred to the tool shaft where it is probed.
X+, X-, Y+, Y-	Moving direction of the axis to calibrate or measure the radius wear. It is selected with the [SPACE] key.

4.

MANUAL (JOG) MODE
Tool calibration

LwT	Maximum length wear allowed. If programmed with a "0" value, there is no maximum wear.						
RwT	Maximum radius wear allowed. If programmed with a "0" value, there is no maximum wear.						
Stop / Chg	Behavior when exceeding the maximum wear allowed. <table border="0" style="margin-left: 20px;"> <tr> <td style="padding-right: 10px;">"Stop"</td> <td>It shows a message of rejected tool and stops the cycle.</td> </tr> <tr> <td style="padding-right: 10px;">"Chg"</td> <td>The cycle replaces the tool with another one of the same family.</td> </tr> <tr> <td colspan="2" style="padding-top: 10px;">It is selected with the [SPACE] key.</td> </tr> </table>	"Stop"	It shows a message of rejected tool and stops the cycle.	"Chg"	The cycle replaces the tool with another one of the same family.	It is selected with the [SPACE] key.	
"Stop"	It shows a message of rejected tool and stops the cycle.						
"Chg"	The cycle replaces the tool with another one of the same family.						
It is selected with the [SPACE] key.							
XMAX...ZMIN	Probe position. If not defined, the CNC assumes the position set by the OEM. They are only taken into account during the calibration cycle; they do not modify the machine parameter values.						

4.

MANUAL (JOG) MODE

Tool calibration

▼ Calibrate or measure the tool

To calibrate or measure the tool, follow these steps:

1. Select the tool and the offset. It is not necessary to insert the tool into the spindle; the CNC carries out this operation if necessary.
2. Define the rest of the data.
3. To start calibrating or measuring the tool, press [START].
If necessary, the CNC changes the tool and executes the programmed operation. The data is stored in the tool table.

To calibrate another tool, repeat steps 2 and 3.

It allows calling the cycle with certain probe position data other than the ones defined in the machine parameters.



CNC 8070

(SOFT V02.0x)

▼ Selecting the editing and simulation mode



The editing-simulation mode may be accessed from any other operating mode, even while a program is in execution, by pressing the relevant key.

This work mode may be accessed from any channel and even from several channels at the same time. A different program may be edited and simulated in each channel.

▼ What can you do in this work mode?

The following operations are possible in this work mode:

- Edit, modify or view the contents of a part-program.
A program may be edited in CNC programming language (ISO or high level) with the assistance of a conversational editor for machining cycles and positioning assisted by a profile editor or using the TEACH-IN feature.
- Simulate the execution of a program displaying a graphic representation of the program being simulated.
- Estimate the total program execution time and the machining time for each tool.

5.1 Appearance of the editing - simulation

When this operating mode is active, it will be indicated at the top right side of the general status bar.

This mode may be displayed with several screens. The current screen and the total number of available screens are shown at the upper right hand side of the general status bar.

Switching between the different screens is done by pressing the editing-simulation mode accessing key. The screen selection is rotary in such a way that when pressing this key on the last screen, it shows the first one of the operating mode.

Standard configuration

The standard configuration of this work mode, described in this manual corresponds to the one supplied by Fagor. In some cases, the manual shows a sample screen, instead of that of the CNC in order to make it easier to understand.

These screens may be customized by the machine manufacturer changing its contents as well as its appearance. They may also remove certain screens or add some of their own.

5.

EDITING-SIMULATION MODE
Appearance of the editing - simulation



CNC 8070

(SOFT V02.0x)

5.1.1 General screen description

On a typical screen for this work mode, the information is laid out as follows.

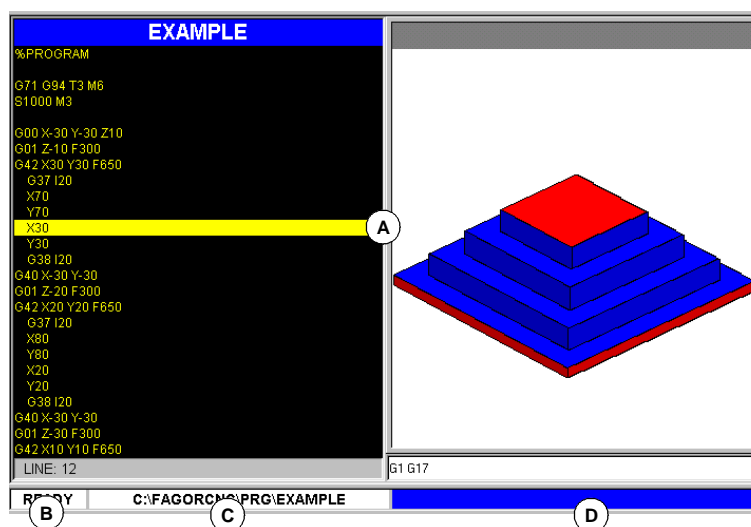

A. Windows of the editing-simulation mode.

It shows the operating windows of the selected screen. Every screen may consist of one or more windows. See ["5.1.2 Window description"](#) en la página 92.

B. Status of the program selected in this work mode or channel number when using them.

In any case, the background color will be different depending on the status of the program being simulated.

Ready	Background color: White.
In simulation	Background color: Green.
Interrupted	Background color: Dark green.
In error	Background color: Red.

C. Program name and location.

The background color will be different depending on the status of the program.

D. CNC messages.

5.

EDITING-SIMULATION MODE
Appearance of the editing - simulation

5.1.2 Window description

As mentioned earlier, each screen may consist of one or many of the following windows (later sections of this chapter describe each one of them in greater detail):

- **Edit window:** For editing new programs or modify the existing ones. Editing is possible using a profile editor, a conversational canned cycle editor or using the TEACH-IN feature.
- **Graphic window:** This window shows a graphic representation of the program during the simulation. It also allows taking measurements on the graphics.
- **Program window:** For selecting the starting and ending conditions of the simulation.
- **Statistics window:** For estimating the machining time for each tool and the total program execution time.



When the screen consists of several windows, the softkey menu will show the options of the active window. To switch windows and access the desired softkey menu, press the relevant key.

5.

EDITING-SIMULATION MODE

Appearance of the editing - simulation

5.1.3 Icon description (vertical softkeys)

The icons are activated with their associated softkey (F8 to F12).



The icon menu always shows all the icons related to this operating mode regardless of which window is active. The group of icons of this menu may be expanded with the softkey associated with the "+" icon that offers a new set of icons.

List of icons



START (simulation)

(This icon will not be available while simulating a program).

It starts the program simulation or resumes it if it was interrupted.

During simulation, the graphic window will show the graphic representation of the program being simulated.



STOP (simulation)

(This icon will only be available when simulating a program).

It interrupts program simulation.

Simulation will resume by pressing the START icon.



RESET (simulation)

It cancels program simulation.

If an error occurs during simulation, it eliminates the error status and returns the simulation mode to its initial conditions.

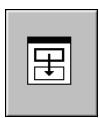

Channel change for the editing and simulation mode

(This icon will only be available when using channels).

It serves to change the channel being displayed for editing and simulation. It does not affect the active channel at the CNC.



"Continuous" or "single block" mode

It selects the "single block" or "continuous" mode. Either one may be selected even while executing a program.

When "single block" mode is active (the icon will appear pressed), program simulation will be interrupted at the end of each block. When the "automatic" mode is active, the simulation will take place until the end of the program or up to the block selected as end of simulation.

5.

EDITING-SIMULATION MODE
 Appearance of the editing - simulation



Check program syntax

It analyzes the program looking for syntax errors.

If there are no errors, the bottom of the screen will display a message indicating that the program is correct. If there are syntax errors, they will be shown at the bottom of the editing window.

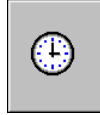

Time estimates

(This icon is only available when the statistics window is displayed).

It offers an estimate of the total execution time at 100% of the programmed feedrate. For this time estimate, the CNC analyzes:

- The machining and positioning time for each tool used in the program.
- The number of "M" functions that are executed.
- The number of tool changes performed.

The result will appear at the statistics window.



Simulation setup

It shows the simulation setup options.

- Activate and cancel tool radius compensation.
- Conditional stop.
- Activate and deactivate the software travel limits.
- Block skip condition.
- Cancel the channel synchronization in the simulation.

5.2 Editing window

It may be used to edit, modify or see the contents of a part-program and check the program for syntax errors.

Description of the editing window

The editing window shows the following information:

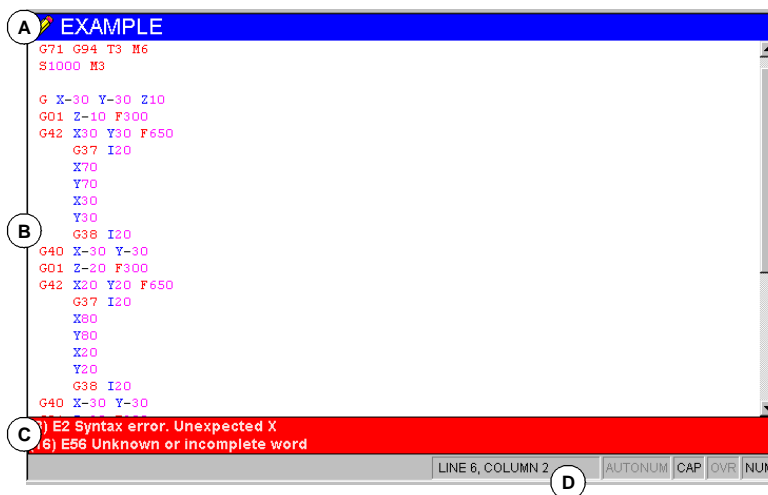

A. Title bar

Name of the program selected for editing. It also indicates whether it is a read-only program or not (if read-only, while simulating or executing).

An "*" next to the program means that the program has been modified since last saved (only if automatic program saving is off).

B. Edit area.

Program editing area showing its contents.

C. Editing errors (if any).

List of errors occurred while editing the program or syntax errors found in the syntax check.

D. Status bar.

Information about cursor position and the status of the editor options such as:

AUTONUM:Automatic block numbering. When active, the CNC automatically numbers the new blocks being generated.

CAP:Capital letters. When active, the text is always written in capital letters.

OVR:Overwrite text. It toggles between overwriting and inserting text. When active, it overwrites the existing text.

NUM:Numeric keypad active.

Softkey menu of the editing window

When selecting the editing window, the horizontal softkey menu shows the options for this window. The set of options offered by this menu may be changed using the "+" softkey which offers a new set of options.

5.

EDITING-SIMULATION MODE
Editing window

FAGOR 

CNC 8070

(SOFT V02.0x)

5.

EDITING-SIMULATION MODE
Editing window

The options available in the softkey menu are the following. See **"5.3 Editing window (softkeys)"** en la página 102.

- "Open program"
To open a program for the editing - simulation mode.
- "File"
To restore, save, save with another name or print a program. It can also be used to import the contents of another program, of a DXF file or PIM and PIT files.
- "Undo"
To "undo" the last modifications made.
- "Operations with blocks"
To copy, cut and paste information of a block or set of blocks within the program. It can also copy a block or set of blocks as an independent program.
- "Find/replace"
To search for a line or text in the program being edited. It can also replace a text with another text.
- "Customize"
To customize the appearance and the properties of the editing window.
- "Profile editor"
To access the profile editor and define a new profile or modify an existing one.
- "Cycle editor"
To access the conversational editor for machining and positioning canned cycles.
- "TEACH-IN ON / TEACH-IN OFF"
To turn on or off the TEACH-IN mode.



CNC 8070

(SOFT V02.0x)

5.2.1 Program editing

The process of editing or modifying a program is the following:

1. Open the program at the editor or create a new program.
2. Use the cursor to select the block where the new blocks will be inserted. Edit the program blocks using the editing modes available.
3. Save the program so it can be modified or executed later on. This operation may be performed automatically as the program is being edited or if the editor has been personalized.

Available editing modes

Any of the various editing modes available may be used while editing a program. The available editing modes are:

CNC language

It is edited block by block and each one may be written in ISO language or in High level language.

When editing high level commands and depending on the type of command, the editor offers a list of available commands.

- Keying in "V" shows the list of CNC variables.
- Keying in "#" shows the list of CNC instructions.
- Keying in "\$" shows the list of flow control instructions of the CNC.

In all of them, when keying the following letter of the variable or instruction name, the cursor of the list goes to the first command that starts with that letter. The [↑][↓] keys may be used to move the cursor through the list of commands and the [ENTER] key to enter the selected command into the block that is being edited.

Conversational editor for canned cycles

To define machining and positioning canned cycles quickly and easily. This mode offers the following advantages:

- There is no need to know the canned cycle parameters.
- The CNC only lets entering the data being shown, thus avoiding any data entry errors when defining the cycles.
- The programmer is assisted at all times with help messages.

When done editing the cycle, the CNC generates the necessary blocks and it will add them to the program inserting them after the block indicated by the cursor.

5.

EDITING-SIMULATION MODE
Editing window

FAGOR 

CNC 8070

(SOFT V02.0x)

5.

EDITING-SIMULATION MODE
Editing window

Profile editor

To edit new profiles quickly and easily. The editor shows a graphic representation of the profile being defined.

After defining the profile data, the CNC generates the necessary blocks and it will add them to the program inserting them after the block indicated by the cursor.

TEACH-IN

It is basically the same as editing in CNC language, except when it comes to programming coordinates. This option displays the coordinates of each axis and lets enter them directly into the block indicated by the cursor.

5.2.2 Import DXF files

DXF files may be imported from the editor to the program being edited. See **"5.3.2 File"** en la página 103.

The DXF format is standard for exchanging graphic files. Importing this type of files makes it possible to generate the part-program directly from a drawing. The DXF file may consist of points, lines and arcs. It can also consist of polylines, but they must be previously uncombined.

When selecting this option, the CNC shows a list of the programs that may be imported into the one being edited. Select the desired program from the list and press [ENTER].

After selecting the file, define how the various layers of the DXF file are to be converted into ISO code. Once this data has been set, press the "Convert" softkey to import the file into the part-program.

DXF file configuration

When importing a DXF file, it shows the configuration window to define how the different layers of the drawing must be treated. The configuration window shows three areas clearly and distinctly.

Layer description area

The DXF files may consist of layers and each one has different heights of the drawing. All the layers together make up the whole drawing.

When importing the file, you can decide which layers to include in the part-program. By default, all the layers are included. To exclude a layer, select it and press the "Disable layer" softkey.

For each layer, it indicates its priority and offset (height) on the perpendicular axis.

Layer priority and offset

It shows the data of the layer selected by the cursor. For each layer, one must define its priority and offset (height) on the perpendicular axis.

- The priority defines the order in which the layers will be executed; i.e. the order in which they will be included in the part-program. Those with priority ·1· will be executed first and so on.
- The offset (height) on the perpendicular axis permits executing each layer in the desired Z coordinate (or that of the relevant perpendicular axis).

5.

EDITING-SIMULATION MODE
Editing window

FAGOR 

CNC 8070

(SOFT V02.0x)

Work plane

The work plane must be defined before importing the file in the part-program. The plane is defined by selecting the abscissa axis, the ordinate axis and the perpendicular axis.

When importing it in the profile editor, the plane will be the one selected at the editor and only the perpendicular axis can be selected.

5.

EDITING-SIMULATION MODE
Editing window



CNC 8070

(SOFT V02.0x)

5.2.3 Syntax errors when editing

The syntax errors occurred while editing or after running a syntax check will be displayed at the bottom of editing window.

To toggle the cursor between the editor and the error listing, press the key combination [CTRL]+[TAB].

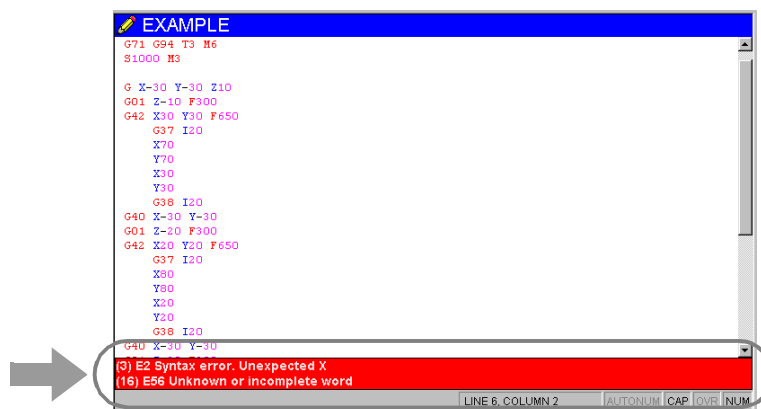

5.

EDITING-SIMULATION MODE
Editing window

Errors while editing

While editing, each block is analyzed when entered. If a syntax error is detected in the block, the error window will display the following information:

- Position of the error in the block.
- Error number and explanatory text.

Errors after a syntax check

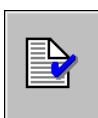

The syntax check is executed from the icon menu.

The syntax check checks all the blocks of the program. If a syntax error is detected, the error window will show the following information.

- Location and name of the program being checked.
- Line number and position of the error within the block.
- Explanation of the error.

Moving the cursor through the errors of the window, the editor will highlight the block containing the selected error. Press [ENTER] to select the block containing the error or press [ESC] to close the error window.



CNC 8070

(SOFT V02.0x)

5.3 Editing window (softkeys)

5.3.1 Open program

To select a program for the editing - simulation mode. This program may be a new one or an existing one. A different program may be edited and executed in each channel.

When selecting this option, the CNC shows a list of the available programs. See ["2.5 File selection window"](#) en la página 24.

To select a program from the list:

1. Select the folder that contains the program. If it is a new program, it will be saved in this folder.
2. Select the program from the list or write its name in the bottom window. To edit a new program, write the name of the program in the bottom window.
3. Press [ENTER] to accept the selection and open the program or [ESC] to cancel it and close the program listing.

5.

EDITING-SIMULATION MODE
Editing window (softkeys)

5.3.2 File



It is used to restore, save, import or print a program.

When selecting this option, the softkey menu shows the available options. To return to the main menu, press the key for the previous menu.

File "Restore original"

This option is only available when the "auto save" option is active. See ["5.3.6 Customizing"](#) en la página 108.

It is used to restore the original program without the changes made since the last time it was opened. When selecting this option, the CNC requests confirmation of the command:

Keys to move the cursor	
	Moves the cursor through the selection buttons.
	Applies the option selected with the cursor.

File "Save"

This option is only available when the "Manual save" option is active. See ["5.3.6 Customizing"](#) en la página 108.

To save the program being edited.

File "Save as"

It is used for saving a program that is being edited with a different name. After saving the program, one may continue editing the new program

When selecting this option, the CNC shows a list with all the programs already saved.

Keys for selecting a file	
	To switch windows.
	To close and open a folder submenu.
	To move the cursor thru the elements of the window.
	To save the new program.
	To cancel the selection and close the program listing.

To save a program with another name:

1. Select the destination folder.
2. Write the program name in the bottom window. To replace an existing program, select it from the list
3. Press [ENTER] to save the program or [ESC] to return to the editor without saving the program.

Once the program has been saved, the top of the editing window will show the name of the new program.

5.

EDITING-SIMULATION MODE
Editing window (softkeys)





5.

EDITING-SIMULATION MODE
 Editing window (softkeys)

File "Include program"

It may be used to import the content of a part-program into the one being edited. Any program that may be accessed from the CNC may be imported, even the program currently in execution.

When selecting this option, the CNC shows a list of the programs that may be imported into the one being edited.

Keys for selecting a program	
	To switch windows.
	To move the cursor thru the elements of the window.
	To import the selected program.
	To cancel the selection and close the program listing.

To import a program from the list:

1. Select the desired program from the list or write its name in the bottom window.
2. Press [ENTER] to import the program or [ESC] to cancel the selection and close the program listing.

The selected program is added to the one being edited after the block indicated by the cursor.



The program may be selected from the list as follows:

- *By moving the cursor to the desired element.*
- *Using the alphanumeric keyboard. Pressing a key will select the first element from the list starting with that letter or number. Pressing it again will select the second one and so on.*

Programs may also be selected using the "File search" option of the softkey menu.

File "Print"

It is used to print the program that is being edited out to a printer connected to the CNC.

File "Import"

It permits importing DXF, PIM and PIT files into the program being edited. See "[5.2.2 Import DXF files](#)" en la página 99.

- The DXF format is standard for exchanging graphic files. Importing this type of files makes it possible to generate the part-program directly from a drawing. The files must consist of points, lines and arcs.
- PIM and PIT files are part-programs used by the 8055 CNC. When importing this type of file, its programming language is adapted to the one used by the CNC.

When selecting this option, the CNC shows a list of the programs that may be imported into the one being edited. Select the desired program from the list and press [ENTER].

5.3.3 Undo

To "undo" the last modifications made. The modifications are undone one by one starting from the most recent one.

5.**EDITING-SIMULATION MODE**
Editing window (softkeys)**FAGOR** **CNC 8070**

(SOFT V02.0x)

5.3.4 Operations with blocks

It is used to copy, cut and paste the information of a block or set of blocks and export this information as an independent program.

This option is only available when there is a text selected in the program or on the clipboard. To select a text in the program, keep the [SHIFT] key pressed while moving the cursor.



When selecting this option, the softkey menu shows the available options. To return to the main menu, press the key for the previous menu.

Operations with blocks "Copy"

It copies the selected text onto the clipboard.

Operations with blocks "Cut"

Copies the selected text onto the clipboard and deletes it from the program.

Operations with blocks "Paste"

Pastes the contents of the clipboard into the program.

Operations with blocks "Copy to program"

Saves the selected texts as an independent program.

When selecting this option, the CNC shows a list of the available programs.

Keys for selecting a program	
	To switch windows.
	To close and open a folder submenu.
	To move the cursor thru the elements of the window.
	To import the selected program.
	To cancel the selection and close the program listing.

To save the text as a program:

1. Select the destination folder.
2. Write the program name in the bottom window. To replace an existing program, select it from the list.
3. Press [ENTER] to save the program or [ESC] to cancel the selection and close the program listing.

5.3.5 Find/replace

It is used for searching for a line or a text in a program. It can also replace a text with another text.

When selecting this option, the CNC shows a dialog box requesting the line number or the text to look for. When defining a text search, certain options may also be defining that allow:

- A. Replacing the text being searched with another in the program.
- B. Ignore uppercase and lowercase.
- C. Consider the text to find as a whole word.
- D. Select whether the search starts at the beginning of the program or at the cursor position.

Find/replace

FIND / REPLACE

GO TO LINE

FIND TEXT

REPLACE WITH

A MATCH CASE

B MATCH WHOLE WORD ONLY



C

START

BEGINNING

CURSOR

D

	To move the cursor through the elements of the list.
<input type="text" value="SPACE"/>	To activate/deactivate the selection box (B) (C).
	To select an option of a group (D).
<input type="text" value="ENTER"/> 	To start the search.
<input type="text" value="ESC"/>	To cancel the search and close the dialog box.

After defining the search options, press [ENTER] to start the search or [ESC] to cancel it.

The text found in the program will be highlighted and the softkey menu will show the following options:

- Replace, to replace the highlighted text.
- Replace all, to replace the text throughout the whole program.
- Find next, to skip this text and keep on searching.

To end the search, press [ESC].

5.

EDITING-SIMULATION MODE
Editing window (softkeys)

5.3.6 Customizing

To customize the appearance and the properties of the editing window.



When selecting this option, the softkey menu shows the available options. To return to the main menu, press the key for the previous menu.

Customizing "Appearance" (looks)

It is used for personalizing the look of the different elements of the editing window and the colors of the elements of the program.

When selecting this option, the CNC shows the dialog box with two panels. The first one has the elements of the editing window that may be customized and the second one those of the program. The panel is selected by the key combination [CTRL]+[TAB].

Set aspect

CTRL + [Left/Right Arrow]

GENERAL OPTIONS | SINTAX COLORING

EDITOR
ERROR WINDOW
TITLE
STATUS BAR
TEACH-IN

FONT: Courier New
13 SIZE
 ITALIC
 BOLD

TEXT [Color Picker] BACK [Color Picker] TEXT [Button]

To move the cursor through the elements of the list.
 To select an option of a group (A).
 SPACE To turn on/off the checkboxes (C), and to open/close the drop lists (B).

After defining the new look, use the cursor to select one of the buttons here below to accept or ignore the changes made and press [ENTER].

Aceptar Cancelar Aplicar

(A) To accept the changes and close the dialog box.
 (B) To ignore the changes and close the dialog box.
 (C) To apply the changes and close the dialog box.

The dialog box may also be closed directly without accepting the changes by pressing [ESC].

Customizing "Auto-Save / Manual save"

It is used to save the program automatically or manually.

- When "auto-save" is on, the CNC will automatically save the program after every change.
- If "Manual save" is active, it is up to the operator to save the program. See "5.3.2 File" en la página 103.

Customizing "Autonumbering ON / Autonumbering OFF"

It is used to turn on/off the autonumbering of the blocks. While autonumbering is active, the CNC will insert the block number automatically every time a new block is generated.

Customizing "Autonumbering parameters"

It is used for selecting the starting block number and the sequencing step for the following blocks when autonumbering the blocks.

When selecting this option, the CNC shows a dialog box requesting both data. After defining these values, press [ENTER] to accept them or [ESC] to ignore them.

Customizing "TEACH-IN parameters"

It may be used to set the behavior of each axis in TEACH-IN mode. The behavior of an axis is defined by the properties "visible" and "selected".

"Visible"	The axis is displayed in the TEACH-IN window.
"Selected"	The axis is included in the blocks that are edited by pressing the [RECALL] key.

Depending on these properties, one of the following behaviors may be assigned to the axes:

- Selected and visible:
The axis is displayed in the TEACH-IN window and it is included in the blocks being edited by pressing the [RECALL] key.
- Not selected and visible:
The axis is displayed in the TEACH-IN window, but it is not included in the blocks being edited by pressing the [RECALL] key.
- Not selected and not visible:
The axis is neither displayed in the TEACH-IN window nor included in the blocks being edited by pressing the [RECALL] key.

After defining the behavior of the axes, press [ENTER] to accept the selection or [ESC] to reject it.

Show / Hide cycles and profiles

It is used for selecting whether the contents of the conversational canned cycles and profiles will be shown or hidden in the program.

- If the "Show" option is active, it will show the full contents of the canned cycle and the profile.
- If the "Hide" option is active, only the name of the canned cycle and the profile will be shown.

5.

EDITING-SIMULATION MODE
Editing window (softkeys)



CNC 8070

(SOFT V02.0x)

5.3.7 Profile editor

It is used for accessing the profile editor.

When selecting this option, the softkey menu shows the profile editor options. To return to editing the program, press "End".

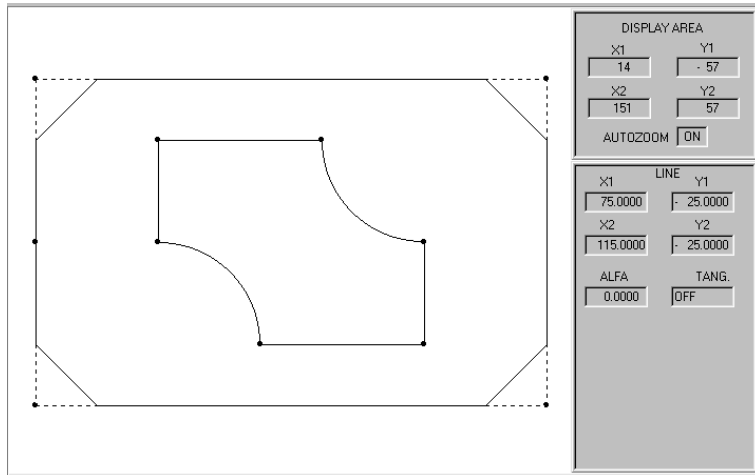

The profile editor may also be accessed by selecting a profile in the program and pressing [RECALL].

The section on **"5.9 Profile editor"** of this chapter offers a more detailed description on how to use the profile editor.

5.
EDITING-SIMULATION MODE
 Editing window (softkeys)



CNC 8070

(SOFT V02.0x)

5.3.8 Canned cycles

It is used to access the conversational canned cycles.



When selecting this option, the softkey menu shows the available canned cycles. To return to the main menu, press the key for the previous menu.

When selecting a canned cycle, the CNC displays the window for defining that canned cycle. Some of these canned cycles may be associated with multiple machining so it is repeated at all points.

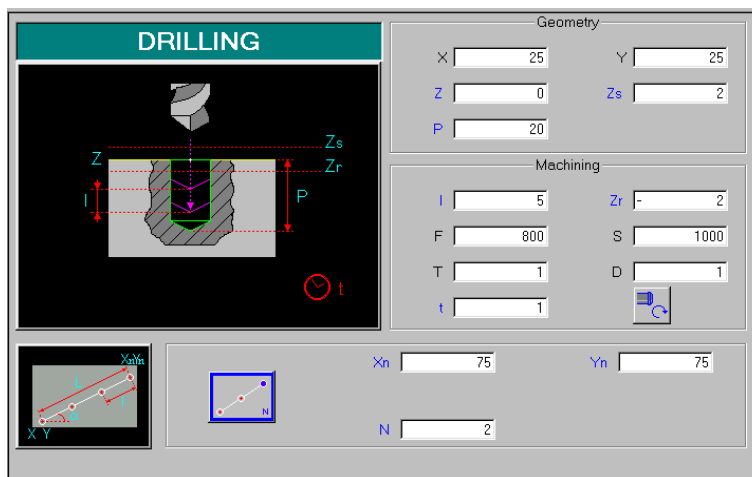

The cycle defining window may also be accessed by selecting a canned cycle in the program and pressing [RECALL].

The cycle being edited may also be simulated in the window for defining the conversational canned cycle.

The programming manual offers a more detailed description of how to define and/or simulate conversational canned cycles.

5.

EDITING-SIMULATION MODE
Editing window (softkeys)



CNC 8070

(SOFT V02.0x)

5.3.9 TEACH-IN ON / TEACH-IN OFF

It is used to activate or deactivate the TEACH-IN mode. In this mode, the axes may be moved manually and their position may be assigned to a block.

When active, the top of the editing window shows the position of the axes defined as “visible” for the TEACH-IN mode. See ["5.3.6 Customizing"](#) en la página 108.

5.
EDITING-SIMULATION MODE
 Editing window (softkeys)

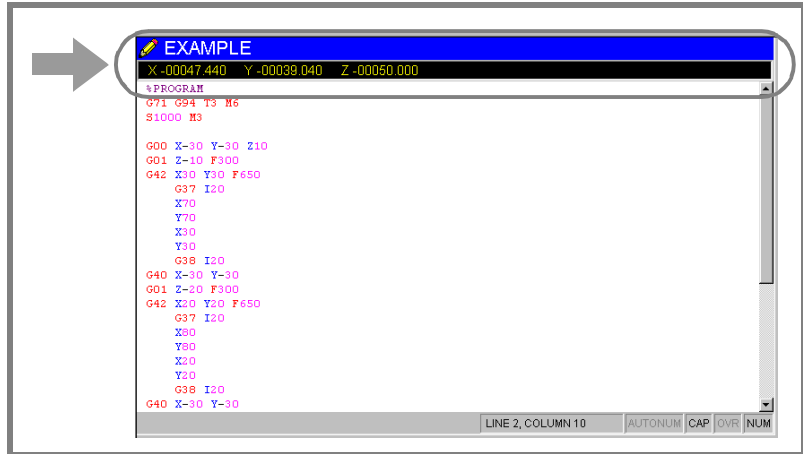

When TEACH-IN mode is active, it is possible to keep editing the coordinates of the axes directly from the keyboard or they may be assigned the current position of the machine axes. Both editing methods may be used indistinctly, even while defining a block.

To define the coordinates of one or several axes using TEACH-IN:

1. Move the axes to the desired position using the JOG keys, the handwheels or the MDI mode.
2. In the part-program, edit the name of the axes whose position is to be defined or not select any axis if you wish to define the position of all of them.
3. Press the [RECALL] key.
 - If an axis has been edited, the CNC assigns the current position of that axis as the program coordinate. The axis is displayed in the TEACH-IN window.
 - If no axis has been edited, a block is edited with the current position of all the axes defined as “selected” for the TEACH-IN mode. See ["5.3.6 Customizing"](#) en la página 108.



CNC 8070

(SOFT V02.0x)

5.4 Graphics window

It is used to show a graphic representation of the program being simulated and take measurements over the drawing.

Description of the graphics window

The graphic window shows the following information:

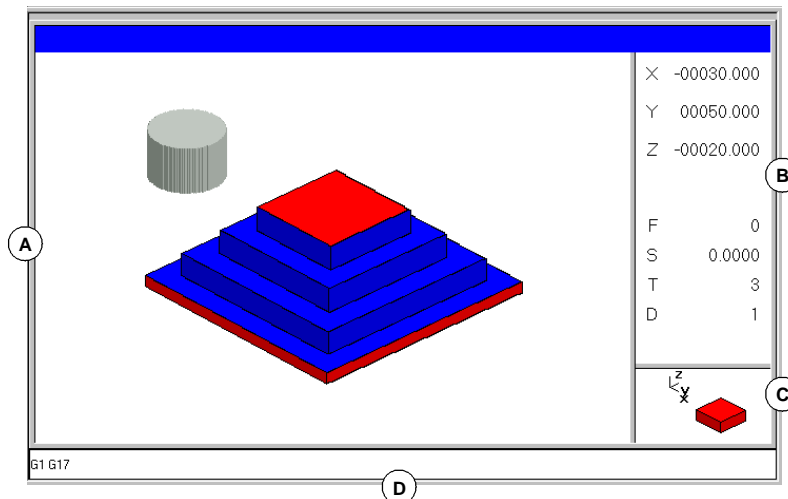

A. Display area.

It shows a graphic representation of the tool paths or of the part as the program is being simulated.

B. Dialog area.

It shows the position of the axes and the machining conditions active during simulation (feedrate, spindle speed, tool and tool offset).

When selecting specific options of the softkey menu, it shows the information associated with that option which may be defined by the user.

C. Information area.

Shows the work plane appearing in the display area and an illustration representing the size of the graph and the portion of the graphic area selected with the zoom.

On 3D graphics, the illustration shows the point of view of the graph displayed and it may be changed by the operator.

Keys for selecting the point of view	
	Select a new point of view.
	Assumes the new point of view selected.
	Cancels the selected point of view.

D. "G" functions active during simulation.

5.

EDITING-SIMULATION MODE
Graphics window

FAGOR

CNC 8070

(SOFT V02.0x)

Softkey menus of the graphics window

When selecting the graphic window, the horizontal softkey menu shows the options associated with that window. The set of options offered by this menu may be changed using the "+" softkey which offers a new set of options.

The options available in the softkey menu are the following. See ["5.5 Graphic window \(softkeys\)"](#) en la página 118.

- "Type of graphics"
To select the type of graphics.
- "ZOOM"
To enlarge or reduce the whole graph shown or part of it.
- "Dimensions"
To define the size of the graphic representation.
- "Point of view"
To change the point of view of the graph and show it from another perspective.
- "Measurement"
To measure the distance between two points.
- "Clear screen"
It is used to clear the screen or delete the graphics displayed.
- "Colors"
To set the appearance of the graphics on display.
- "Options"
To set the appearance and some options of the graphic window.
- "Speed"
To change the simulation speed.

5.

EDITING-SIMULATION MODE
Graphics window



CNC 8070

(SOFT V02.0x)

5.4.1 Program simulation

The graphic window shows the program selected at the editing window and its name appears at the bottom center of the screen.

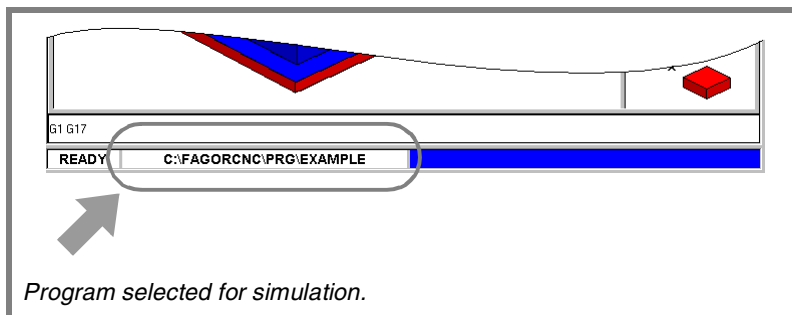

The program simulation procedure is the following:

1. Choose the type of graphic representation, its dimensions and the point of view. This data may also be modified during the simulation of the program.
2. Activate the desired simulation options using the icon menu.
3. Press the START icon to start the simulation. The simulation may be interrupted with the STOP icon or canceled with the RESET icon.

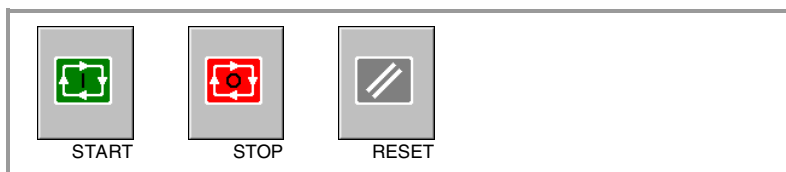

The simulation of the program starts at the first block of the program and ends after executing one of the end-of-program functions "M02" or "M30". As an option, it is possible to define the first and last blocks of the simulation. See ["5.6 Program window"](#) en la página 127.

"Single block" mode of simulation.

If the –single block– mode is active, program execution will be interrupted at the end of each block; the [START] icon must be pressed again to continue.



The –single block– mode is selected from the icon menu and may be selected before or while simulating the program.

5.

EDITING-SIMULATION MODE
Graphics window

Simulation options

The available simulation options are accessed from the icon menu. Pressing the icon displays a window that shows the following options.



Tool radius compensation

It activates or cancels tool radius compensation to simulate the program.

Tool radius compensation being off, the simulation will ignore the programmed tool radius compensation.



Conditional stop during simulation

It simulates the external "conditional stop" switch.

While active, the program simulation will be interrupted at the blocks having a "conditional stop" function "M01". The simulation will resume when pressing the START icon.



Software limits

It activates or deactivates the software limits for program simulation.

With the limits activated, if the software limits are reached during simulation, a simulation error message will be issued. If not active, the software limits will be ignored during simulation.



Block jump

It simulates the external "block skip" switch.

While active, the blocks having the block-skip character "/" will be ignored (not simulated).



Cancel channel synchronization

There is one icon for each channel. It cancels the channel synchronization wait periods during simulation.

When active, the wait period will end immediately and it will resume the execution of the program.

5.4.2 Simulation errors

When an error occurs, the CNC will display a window describing the cause of the error. These errors are displayed in the middle of the screen, regardless of which window is active.

There are two types of errors. The top of the window shows the category and it will have a different color depending on the type of error it shows.

WARNING

They do not interrupt the simulation of the program.

The window that shows them may be removed by pressing [ESC].

ERROR

They interrupt the simulation of the program.

Although the window displaying them may be closed by pressing [ESC], it does not mean that the error status has been taken care of. To do that, press the [RESET] icon.

The program can be neither edited nor simulated while the error stays state active.

5.**EDITING-SIMULATION MODE**
Graphics window

5.5 Graphic window (softkeys)

5.5.1 Type of graphics

To select the type of graphics.

The various types of graphics may be line (3D lines, XY, XZ, YZ and Combined) or solid (Sections and 3D solid). Line graphics show the tool path with lines of different colors and solid graphics show an image of the part being simulated.

The type of graphics selected will remain active until another type is selected or the graphic display is deactivated or the CNC is turned off. Likewise, when changing the type of graphics, the CNC will maintain the graphic conditions (zoom, graphic parameters, display area, etc.), defined for the last graphic.



When selecting this option, the softkey menu shows the types of graphics available. To return to the main menu, press the key for the previous menu.

"3D lines" Graphics

It displays a three-dimensional graph of the tool paths.

"Sections" Graphics

It displays a top view (XY plane) of the part being simulated. It shows the machining depths in different tones. It also displays the XZ and YZ sections for the areas shown by the indicators of the top view.

These indicators may be moved around using the [↑][↓][←][→] keys, to display the different sections of the part. The CNC shows dynamically the new section being selected.

The indicators may be moved at any time even while simulating the program.

"XY" - "XZ" - "YZ" graphics

It displays the tool paths in the XY, XZ or YZ plane.

"Combined" graphics

It divides the display area in four quadrants and displays the tool path corresponding to each plane XY, XZ, YZ and to the 3D view.

"Solid 3D" Graphics

It shows a 3D view of the part being simulated. Starting out with a 3D block which is "machined" as the program is simulated.







5.

EDITING-SIMULATION MODE
Graphic window (softkeys)

5.5.2 Zoom

To enlarge or reduce the whole graph shown or part of it. This option is not available in the "Combined" type of graphics.

After selecting the zoom option, a zoom frame will appear over the graphics. This frame may be enlarged, reduced and moved around over the graphics already displayed in order to select a particular portion of it to zoom into or out of.

Keys for selecting the zoom	
	<i>To move the zoom frame around.</i>
	
	
	
	<i>To change the size of the zoom frame.</i>
	
	<i>To validate and display the selected zoom area.</i>

The graphics at the lower right-hand side of the screen shows two figures. The one shown with lines only, indicates the dimensions of the display area and the one with colored sides indicates the portion selected with the zoom.



When selecting this option, the softkey menu shows the available zoom options. To return to the main menu, press the key for the previous menu.

Zoom "Initial"

Restores the size of the display area set via program or using the "Dimensions" option.

Zoom "Automatic"

The CNC uses the zoom that it considers best according to the movements programmed.

Zoom "Previous"

It displays up to two zooms defined earlier. After the second one, it shows again the one defined last.

Zoom "Limits"

Only for the "Sections" type. In this graphics, zooming is done by moving the indicators that appear framing the graphic sections.

With this option, it is possible to select the axis whose indicator is to be moved.

The indicator may also be selected with the "+" and "-" keys of the numeric keyboard in a rotary fashion (Xmin, Xmax, Ymin, Ymax, Zmin, Zmax).

5.

EDITING-SIMULATION MODE

Graphic window (softkeys)







CNC 8070

(SOFT V02.0x)

Zoom "Edit"

It is used to manually edit the zoom values. It is edited in the dialog area of the graphic window that shows the dimensions of the zoom frame

Keys for defining the zoom	
 	To move the cursor through the data.
	To validate and display the defined zoom area.
	To cancel the defined zoom.

5.

EDITING-SIMULATION MODE
Graphic window (softkeys)

5.5.3 Dimensions

It is used to define the size of the graphic representation by setting the maximum and minimum coordinates of the graphics on each axis.







When selecting this option, the softkey menu shows the options available for setting the dimensions. To return to the main menu, press the key for the previous menu.

Dimensions "Automatic"

The CNC sets the dimensions that it considers best according to the movements programmed.

Dimensions "Edit"

It is used to manually edit the dimension values. It is edited in the graphic window that shows the dimensions of the graphics on each axis.

Keys for setting the dimensions	
 	To move the cursor through the data.
	To validate and display the set dimensions.
	To cancel the set dimensions.







5.

EDITING-SIMULATION MODE
Graphic window (softkeys)

5.5.4 Point of view

It is used to select the point of view on 3D graphics.

The orientation of the graphics may be directly selected at the graphic window by orienting the XY plane and the Z axis. The XY plane may be rotated 360° and the Z axis 90°. The figure at the lower right-hand side of the screen shows the point of view currently selected.





Keys for selecting the point of view	
 	To orient the XY plane
 	To orient the Z axis
	To validate and display the selected point of view.
	To cancel the selected point of view.



When selecting this option, the softkey menu shows the options available for selecting the point of view. To return to the main menu, press the key for the previous menu.

Point of view "Edit"





It is used to manually edit the orientation of the axes of the graphics. It is edited in the dialog area of the graphic window that shows the current orientation of the axes.

Keys for defining the point of view	
 	To move the cursor through the data.
	To validate and display the defined point of view.
	To cancel the defined point of view.

5.5.5 Measurement

To measure the distance between two points. This option is only available for the types of graphics "XY", "XZ", "YZ" and "Solid 3D".

When selecting this option, the section being measured will appear on the graphics with two cursors and a dashed line. The cursor currently selected will appear in red.

Keys to move the cursors	
	<i>To move the selected cursor.</i>
	
	
	<i>To select the cursor to be moved.</i>

The dialog area will show the coordinates of both cursors, the distance between them on the straight line and the components of that distance on the axes of the active plane. The coordinates of the selected cursor will appear in red.





When selecting this option, the softkey menu shows the available options. To return to the main menu, press the key for the previous menu.

Measurement "Point1" & "Point2"

It is used to select the cursor to be moved (same as using the "+" key).

Measurement "Edit"

It is used to manually edit the position of the cursors. It is edited in the dialog area of the graphic window that shows the position of both cursors.

Keys for defining the measurement	
 	<i>To move the cursor through the data.</i>
	<i>To validate the selected position of the cursors.</i>

5.5.6 Clear screen

It is used to clear the screen or delete the graphics displayed.

If a solid graphic type is selected, the graphic representation will be reset and it will return to its initial state without machining.

5.

EDITING-SIMULATION MODE
Graphic window (softkeys)

5.5.7 Colors

5.

EDITING-SIMULATION MODE
 Graphic window (softkeys)

It is used to change the colors used in the graphic representation.

Path colors

When a line graphics is active, it will set:

- The color to draw the rapid traverse.
- The color to draw the canned cycles.
- The color to draw the compensated path.
- The color to draw the theoretical path.
- The color to draw the threading.
- The background color of the window.

Colors for solids

When solid graphics is active, it will set:

- The color to draw the outside X.
- The color to draw the inside X.
- The color to draw the outside Y.
- The color to draw the inside Y.
- The color to draw the outside Z.
- The color to draw the inside Z.
- The background color of the window.











When selecting this option, the softkey menu shows the available options. To return to the main menu, press the key for the previous menu.

Colors "Apply"

It assumes the new colors and applies them to the blocks drawn next. If the new colors are not applied, the graphics are drawn with the old colors.

Colors "Edit"

It is used to select the new colors for the graphics. They are selected in the dialog area of the graphic window that show the current colors.

Keys for defining colors	
 	To move the cursor through the data.
	To open and close the color palettes.
	To move the cursor through the colors of the palette.
  	
	To cancel the selected colors.

5.5.8 Options

It is used to set the appearance and some functions of the graphic window. These options may be used at any time, even while simulating a program.



When selecting this option, the softkey menu shows the available options. To return to the main menu, press the key for the previous menu.

Option "Activate" / "Deactivate"

It is used to activate or deactivate the graphic representation.

When the graphic representation is deactivated and activated, the current graphic is erased; but the display conditions are kept active (type of graphics, zoom, graphic parameters and display area) that were active before that mode was deactivated.

Option "Simple" / "Combined"

It is used to hide or show the dialog and data areas on the right-hand side of the graphic window so the drawing occupies the whole graphic window.

Option "Hide Tool" / "Show Tool"

It is used to hide or show the tool while simulating in "3D solid" graphics.

Option "Print"

It is used to print the graphics in a printer connected to the CNC or as a file (BMP format) at the CNC. When printing to a file, it is saved in the folder:

"C:\Cnc8070\Users\Reports*.bmp"

When selecting this option, the CNC will show a dialog box requesting the print destination (printer or file).

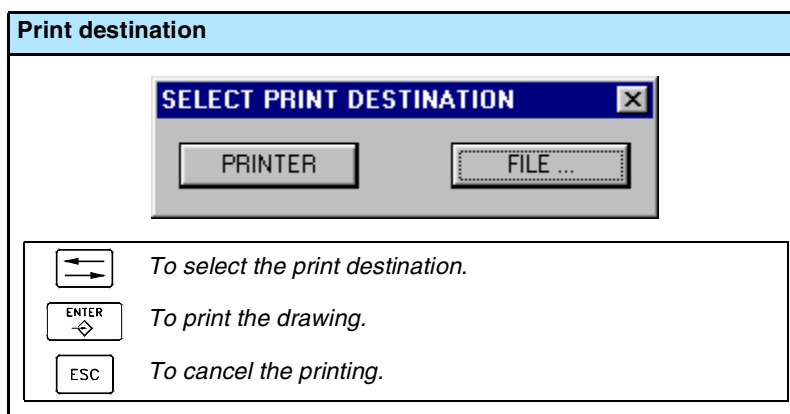

After selecting the destination, press [ENTER] to print it or [ESC] to cancel it.

5.

EDITING-SIMULATION MODE
Graphic window (softkeys)

5.

EDITING-SIMULATION MODE
 Graphic window (softkeys)

Option "Print setup"

It is used to set the printing configuration.

When selecting this option, the CNC shows a dialog box where the following may be defined:

- A. The title of the graphics that will appear next to it in the print.
- B. The name of the file where the graphics will be stored when printing out to a file.

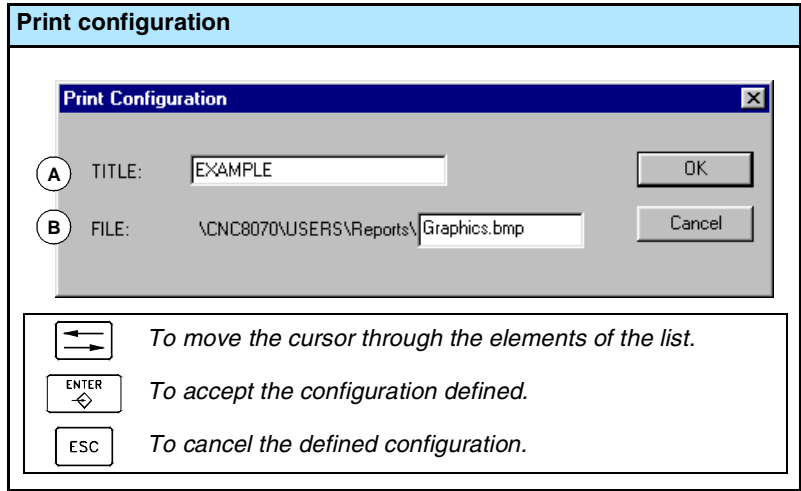

After filling out the data, press [ENTER] to accept them or [ESC] to cancel them.

5.5.9 Speed



To change the simulation speed.

When selecting this option, the softkey menu shows the options to set the simulation speed. To return to the main menu, press the key for the previous menu.

Speed "Edit"

It is used to select the new simulation speed. It is selected using the graduated ruler that indicates the active simulation speed.

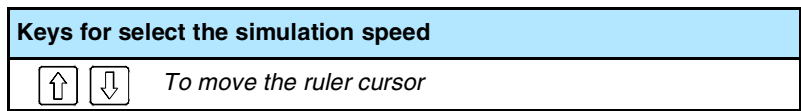

5.6 Program window

It shows the contents of the program selected for simulation and allows selecting the first and last blocks of the simulation. When not selected, the simulation will begin at the first block of the block and will end after executing one of the end-of-program functions "M02" or "M30".

While simulating, the window cursor will show the block being simulated.

5.

EDITING-SIMULATION MODE
Program window

Description of the program window

The program window shows the following information:

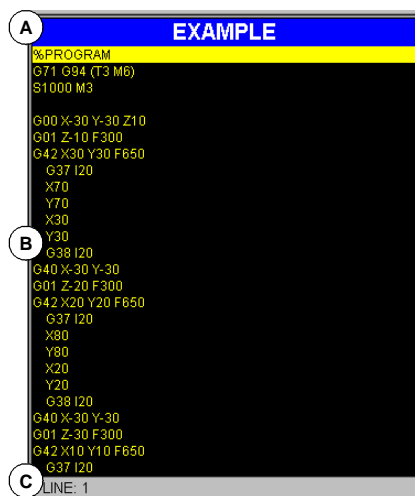

A. Title bar.

Name of the program selected for simulation.

B. Program blocks.

Contents of the program selected for simulation. While simulating, the cursor will indicate the block being simulated.

C. Program line.

Line of the program where the cursor is.

Softkey menus of the program window

When selecting the program window, the horizontal softkey menu will show the options related to this window.

The options available in the softkey menu are the following. See ["5.7 Program window \(softkeys\)"](#) en la página 129.

- "First block"
 - To set the first block of the simulation.
- "Stop condition"
 - To select the block where the simulation of the program or subroutine will be interrupted.
- "Find text"
 - To find text in a program.
- "Go to line"
 - To position the cursor on a particular line of the program.

5.

EDITING-SIMULATION MODE

Program window



CNC 8070







(SOFT V02.0x)

5.7 Program window (softkeys)

5.7.1 First block

It sets as the first simulation block, the block where the cursor is. When not setting the first block, the simulation will begin at the first block of the program.

The last block may be selected using the cursor or the "Find text" or "Go to line" options of the softkey menu.

Keys to move the cursor	
 	Moves the cursor line by line.
 	To move the cursor page by page.
 	Moves the cursor to the first block or to the end of the program.

The first block defined, remains active until canceled (with [ESC]) or until the program is simulated. In that case, the first block of the program will become the first block of the simulation.

5.

EDITING-SIMULATION MODE
Program window (softkeys)

5.7.2 Stop condition

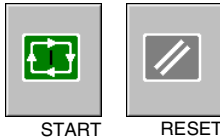

It is used to establish, in the program or in a subroutine, the block where the program simulation will be interrupted. After executing that block, the simulation may be resumed with the [START] icon or canceled with the [RESET] icon.





If no last block is established, the simulation of the program will end after executing one of the end-of-program functions "M02" or "M30".



When selecting this option, the softkey menu of the CNC shows the options available for selecting the stop condition. To return to the main menu, press the key for the previous menu.

Subroutine selection

To select the stop condition in a global subroutine which has been called upon from the program. When selecting this option, the CNC shows a list of programs available for selecting the desired subroutine.

Keys for selecting a program	
 	To move the cursor thru the elements of the window.
	To open the selected subroutine.
	To cancel the selection and close the program listing.

To select a subroutine from the list.







1. Select from the list the program containing the subroutine or write its name in the bottom window.
2. Press [ENTER] to open the program or [ESC] to cancel the selection and close the program listing.

The program window will show the contents of the selected subroutine.

Last block

It sets the cursor position as the block where simulation is interrupted. If no last block is established, the simulation of the program will end after executing one of the end-of-program functions "M02" or "M30".

The last block may be selected using the cursor or the "Find text" or "Go to line" options of the softkey menu.

Keys to move the cursor	
 	Moves the cursor line by line.
 	To move the cursor page by page.
 	Moves the cursor to the first block or to the end of the program.

The established last block remains active until it is canceled (with [ESC]) or a program is simulated. In that case, the execution of one of the functions "M02" or "M30" is set as the stop condition.

Number of times

It sets as stop condition, that the block selected as the last block has been executed a specific number of times.

5.

EDITING-SIMULATION MODE
Program window (softkeys)

When selecting this option, the CNC requests the number of times the block must be executed before finishing. After entering the number of times, press [ENTER] to validate the value or [ESC] to cancel it.

5.

EDITING-SIMULATION MODE
Program window (softkeys)

FAGOR 

CNC 8070

(SOFT V02.0x)

5.7.3 Find text

To find text or a character string throughout the program.

When selecting this option, the CNC shows a dialog box requesting the text to be found. It is also possible to select whether the search must start at the beginning of the program or at cursor position.

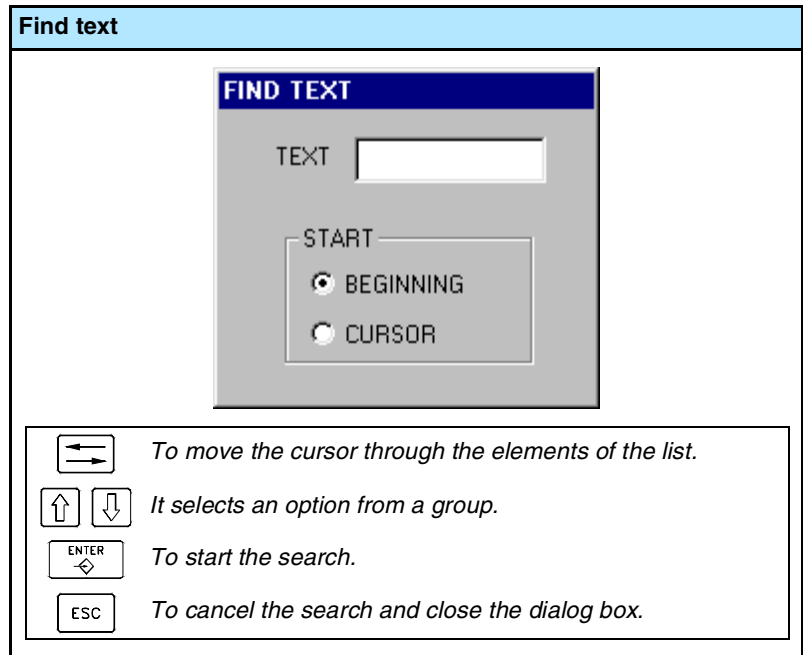

To start the search, press [ENTER] and the cursor will position on the text found. By pressing [ENTER] again, the CNC will look for the next match and so on.

To end the search, press [ESC]. The cursor will position on the block containing the text searched.

5.7.4 Go to line

To position the cursor on a particular line of the program.

When selecting this option, the CNC requests the line number to go to. Key in the desired number and press [ENTER], the cursor will then go to that line.

5.8 Statistics window

It shows an estimate of the total execution time of the program and of the machining time for each tool.

Description of the statistics window

This statistics window shows the following information:

Total Execution Time (s)		173.321
A	Number of M functions:	6
	Number of tool changes:	3
Positioning and machining in seconds		
	TOOL	Positioning
		Machining
	0	0.000
B	1	1.567
	2	0.600
	3	0.840
C	G17	

A. General information.

It shows a time estimate of program execution at 100% of the programmed feedrate, the number of "M" functions executed and the number of tool changes made.

B. Machining time for each tool.

It shows a list of the tools used in the program indicating the machining time for each tool and the total positioning time.

C. "G" functions active during simulation.

5.

EDITING-SIMULATION MODE
Statistics window

5.8.1 Time estimates

The statistics window shows an estimate of the execution of the program selected in the editing window, and whose name appears at the bottom center of the screen.

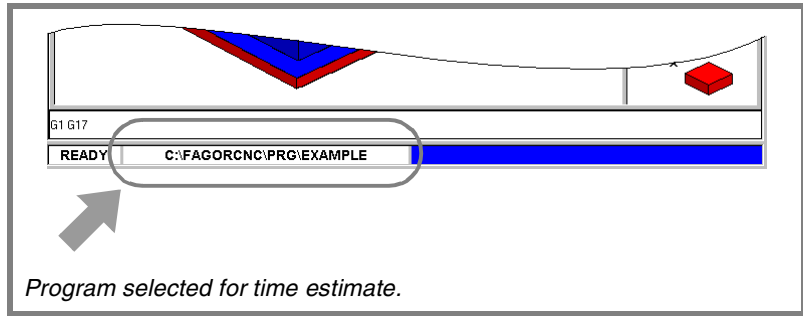

The process to estimate time is the following:

1. Use the program window to select the first and last block for the execution time estimate.

If not selected, the execution time estimate will be done from the first block of the program to the execution of one of the end-of-program functions "M02" or "M30".

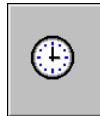

2. Activate the desired simulation options using the icon menu.
3. Start the estimate calculation by pressing its TIMES icon.

Simulation options

These options may also be turned on or off while simulating the program. When they are active, its corresponding icon of the icon menu will appear pressed.

The simulation options available are:



"Single block" mode

It selects the "single block" mode so the execution time calculation is interrupted at the end of each block.



Block jump

It simulates the external "block skip" switch.

When active, the CNC will NOT calculate the execution time of the blocks containing the block-skip character "/".

5.9 Profile editor

The profile editor looks like this.

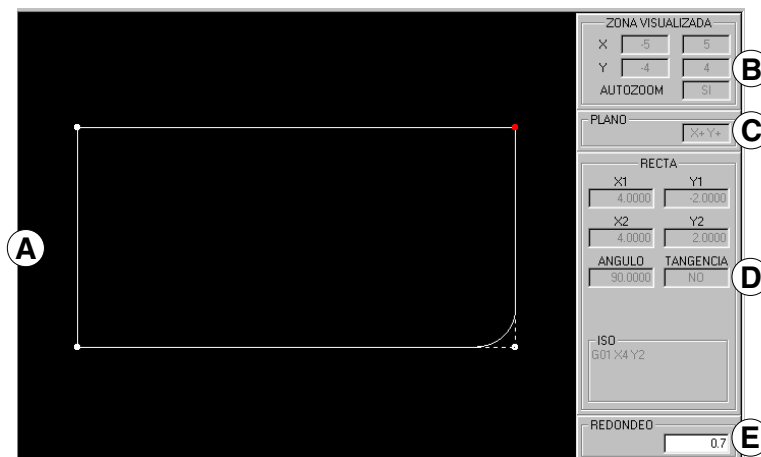

A. Graphic area

Graphic representation of the profile being drawn.

B. Displayed area.

It indicates the size of the graphic area. It is given by the maximum and minimum coordinates of each axis.

It also shows the status of the "Autozoom" option.

C. Work plane.

It shows which are the axes that make up the work plane at the profile editor and the direction of each one of them. The lower left corner of the graphics window is taken as the origin of the coordinate system.

D. Data entry and display area.

Area used to enter and display the data of the elements that make up the profiles.

E. It is used to enter the values of the corners or the ISO coded text to be added to the element.

Softkey menu

The options that may be selected from the softkey menu make it possible to edit profiles, modify edited profiles, select the zoom, the work plane, undo the last change and end the editing session.

While editing or modifying the profile, the softkey menu offers the option to undo the last operation. Likewise, it offers the option to save the profile at any time.

5.

EDITING-SIMULATION MODE
Profile editor

FAGOR 

CNC 8070

(SOFT V02.0x)

5.

EDITING-SIMULATION MODE

Profile editor

When accessing the profile editor, the softkey menu shows the following options:

- Edit

To select the type of profile to be edited. Also too enlarge a profile, import a profile saved in DXF format.
- Modify

To modify, insert or delete elements of a profile.
- Displayed area

To modify the zoom of the graphics area.
- Plane

To select the axes of the plane and their direction.
- End

It ends the profile editing session. Before exiting the profile editor, it will offer the option to save or not the edited profile.
- Undo

To "undo" the last operation made.
- Save and continue

To save the profile and continue editing. Using this key does not require that the profile be completed.

If the profile has been resolved, the CNC will insert it in the part program that is being edited. If the profile cannot be resolved due to lack of data, the CNC will issue the relevant message.

5.9.1 Operating procedure

Several profiles may be edited without having to exit the profile editor. To edit a profile, proceed as follows:

1. Select the type of profile to be edited, such as a circular or rectangular profile or any profile.
2. For a rectangular or circular profile, define its data and insert it. For any profile, first select the starting point of the profile.

Once the first point has been selected, draw the profile, which will be made up of straight and curved sections. If it has corner rounding, chamfering or tangential entries and exits, use one of these methods:

- Treat them as individual sections when having enough information to define them.
 - Ignore them while defining the profile and, once it has been defined, select the corners that have those characteristics and insert them.
3. End the profile editing session by inserting them into the program.

The portion of ISO-code program corresponding to the edited profile will be identified with the line "(#PROFILE)" or it will appear framed between the lines "(#PROFILE BEGIN)" and "(#PROFILE END)".

5.

EDITING-SIMULATION MODE

Profile editor

FAGOR 

CNC 8070

(SOFT V02.0x)

5.9.2 Data editing

All data need not be defined; but it is recommended to define all the known data. To define the profile data, proceed as follows:

1. Press the softkey corresponding to the data to be defined.
2. Key in the desired value (which may be a numeric constant or an expression). Use the [SPACE] key to change the value of a non-numerical data (tangency, direction, etc.).
3. Press [ENTER] to accept the defined value or [ESC] to reject it and return to the previous one. If the entered value is accepted, the CNC will select the next data.

Once all the data has been defined, press the "Validate" softkey and the CNC will show the profile that has been defined.

Displaying incomplete sections

If there isn't enough data to show the defined section, the CNC will draw as much of it as it knows. The sections that are not fully defined will be shown with a dash line.

If there are more than one possibility, it will show the available options one by one except the ones that could generate tangency errors later on; select the desired option. The sections with several possibilities will be shown in green whereas the rest of the sections will be shown in white.

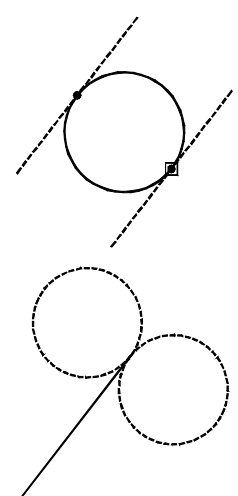

X1 = ?
Y1 = ?
X2 = ?
Y2 = ?
Angle = 60°
Tangent = Yes

X1 = 40 Y1 = 30
X2 = ? Y2 = ?
Xc = ? Yc = ?
Radius = 20
Tangent = Yes

←	→	<i>To select the available options.</i>
↑	↓	
<div style="border: 1px solid black; display: inline-block; padding: 2px 5px;">ENTER</div>		<i>To assume the selected option.</i>

5.9.3 Profile definition

With the softkey menu of this screen, it is possible to define any profile, a circular or a rectangular one or to configure the graphics screen.

When accessing the editing menu, the softkey menu shows the following options:

Profile

To edit any profile by defining the straight and curved sections that make it up. See **"5.9.6 Defining any profile"** en la página 142.

Circle

For quickly defining a circular profile. See **"5.9.4 Circular profile definition"** en la página 140.

Rectangle

For quickly defining a rectangular profile. See **"5.9.5 Rectangular profile definition"** en la página 141.

Expanding a profile

For adding a straight line or an arc in any position of a previously edited profile.

Import profile

For importing a previously saved profile.

These profiles may also be imported in DXF format besides in ISO format.

Undo

To "undo" the last operation made.

Save and continue

To save the profile and continue editing. Using this key does not require that the profile be completed.

5.

EDITING-SIMULATION MODE

Profile editor

FAGOR 

CNC 8070

(SOFT V02.0x)

5.9.4 Circular profile definition



The softkey menu shows the necessary options for defining a circular profile. To return to the main menu, press the key for the previous menu.

X Y	To define the coordinates of the profile's starting point.
Xcenter	To define the profile's center coordinate along the abscissa axis.
Ycenter	To define the profile's center coordinate along the ordinate axis.
Radius	To define the profile radius.
Direction	To define the direction of the profile (clockwise or counterclockwise).
Validate	To accept and draw the defined profile.

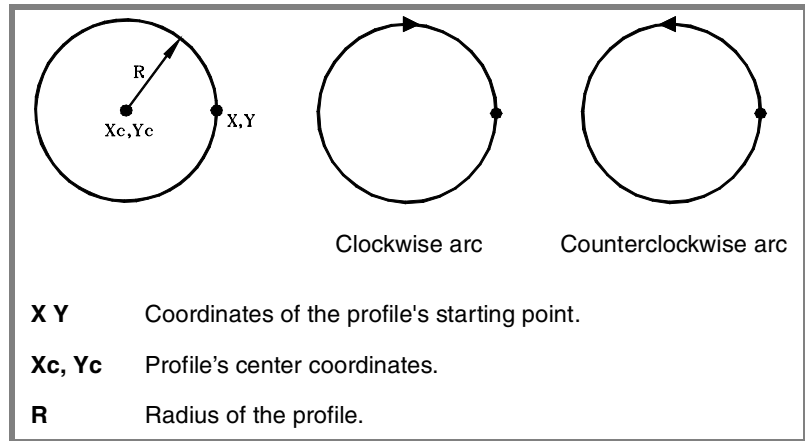

The data is defined in the data area of the screen where the following information is shown:

X1, Y1	Coordinates of the profile's starting point.
XC	Profile's center coordinate along the abscissa axis.
YC	Profile's center coordinate along the ordinate axis.
RADIUS	Radius of the arc.
DIRECTION	It indicates the direction of the profile.

5.9.5 Rectangular profile definition



The softkey menu shows the necessary options for defining a rectangular profile. To return to the main menu, press the key for the previous menu.

- X Y** To define the coordinates of the profile's starting point.
- Length X** To define the profile's length along the abscissa axis.
- Length Y** To define the profile's length along the ordinate axis.
- Angle** To define the angle of the profile referred to the abscissa axis.
- Direction** To define the direction of the profile (clockwise or counterclockwise).
- Validate** To accept and draw the defined profile.

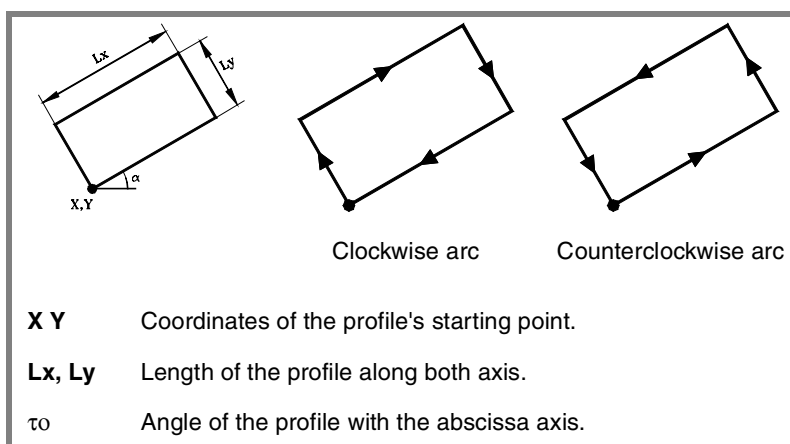

The data is defined in the data area of the screen where the following information is shown:

- X1, Y1** Coordinates of the profile's starting point.
- XL** Profile's length along the abscissa axis.
- YL** Profile's length along the ordinate axis.
- ANGLE** Angle of the profile with the abscissa axis.
- DIRECTION** It indicates the direction of the profile.

5.

EDITING-SIMULATION MODE
Profile editor

5.9.6 Defining any profile

To define a new profile, the CNC request the starting point of the profile. Define it with the relevant softkeys and press the "Validate" softkey. The graphic area will show the profile's starting point.



Once the profile's starting point has been defined, the softkey menu will show the necessary options to define the profile. To return to the main menu, press the key for the previous menu.

- Straight
To edit a straight section.
- Clockwise arc
To edit a clockwise arc.
- Counterclockwise arc
To edit a counterclockwise arc.
- New profile
To edit a new profile.
- Modify the last one
For modifying the last section of the profile.

Definition of a straight section

To define a straight section, the softkey menu shows the necessary options to define the data for the section.

X Y	To define the section's end point.
Angle	To define the angle of the straight section with the abscissa axis.
Tangency	To define whether the section is tangent to the previous path.
Validate	To accept and draw the defined section.
	The data is defined in the data area of the screen where the following information is shown:
X1, Y1	Coordinates of the section's starting point. They cannot be modified because they belong to the endpoint of the previous section.
X2, Y2	Coordinates of the section's endpoint.
ANGLE	Angle of the straight section with the abscissa axis.
TANGENCY	It indicates whether or not the section is tangent to the previous path.

5.

EDITING-SIMULATION MODE
Profile editor



CNC 8070

(SOFT V02.0x)

Definition of a curved section (clockwise or counterclockwise)

To define a curved section, the softkey menu shows the necessary options to define the data for the section.

X Y	To define the section's end point.
Center X	To define the arc's center coordinate along the abscissa axis.
Center Y	To define the arc's center coordinate along the ordinate axis.
Radius	To define the arc radius.
Tangency	To define whether the section is tangent to the previous path.
Validate	To accept and draw the defined section.
	The data is defined in the data area of the screen where the following information is shown:
X1, Y1	Coordinates of the section's starting point. They cannot be modified because they belong to the endpoint of the previous section.
X2, Y2	Coordinates of the section's endpoint.
Xc	Coordinates of the section's center along the abscissa axis.
Yc	Coordinates of the section's center along the ordinate axis.
RADIUS	Radius of the arc.
TANGENCY	It indicates whether or not the section is tangent to the previous path.

5.

EDITING-SIMULATION MODE
Profile editor

5.9.7 Modify a profile and insert corners

To modify the defined profiles by either modifying or deleting the existing elements or inserting new elements. Likewise, it is possible to insert rounding, chamfers and tangential entries or exits.

When selecting this option, the softkey menu will show the necessary options to modify the profile.

□ Modify element

It is possible to modify any data of a section of the profile.

Once the desired element has been selected, one may modify the type of section (straight or arc) or its data. Once the element has been modified, press "Validate" to confirm the changes.

The CNC recalculates the new profile according to the data used to define that section and the next one (tangency, angle, etc.)

□ Insert element

To insert a new element in any position of the profile.

After selecting the section after which the element is to be inserted, select the type of section (straight or arc) to be inserted, define its parameters and press the "Validate" softkey.

The CNC recalculates the new profile according to the data used to define that section and the next one (tangency, angle, etc.)

□ Delete element

To delete an element of the selected profile.

Once the element to be deleted has been selected, confirm the command by pressing [ENTER].

The CNC recalculates the new profile.

□ Corners

To include rounding, chamfers, tangential entries or exits in the defined profile. See "[Corner definition](#)" en la página 145.

□ Additional ISO

For adding an ISO coded line to a previously closed profile.

Once the ISO coded line to be added has been entered, confirm the command by pressing the [ENTER] key.

5.

EDITING-SIMULATION MODE
Profile editor

▼ Corner definition

To include rounding, chamfers, tangential entries or exits in the defined profile.

When selecting this option, the softkey menu shows the type of corners that can be inserted.

Rounding

To insert a rounding at the profiles corners where it is possible.

Chamfer

To insert a chamfer at the profiles corners where it is possible.

Tangential entry





To add a tangential tool entry at the beginning of the profile.

Tangential exit

To add a tangential tool exit at the end of the profile.

Corner definition

Once the type of corner to be inserted has been selected, the CNC will highlight in red one of the corners of the profile.

Keys to select a corner	
 	To select a corner of the profile.
 	To select a corner of another profile.

Select the profile corner to be modified and the CNC will request the value (radius or size) of the corner to be inserted:

- For a rounding, enter the rounding radius.
- For a chamfer, enter the size of the chamfer.
- For a tangential entry, enter the entry radius.
- For a tangential exit, enter the exit radius.

After defining the value of the corner, press [ENTER] to insert the corner in the profile. Then, one may select another corner or quit this mode by pressing [ESC].

5.

EDITING-SIMULATION MODE
Profile editor



CNC 8070

(SOFT V02.0x)

5.9.8 Display area

The softkey menu of this screen may be used to modify the zoom of the graphics area.

When accessing the "display area" menu, the softkey menu shows the following options:

Zoom +, zoom -

To enlarge or reduce the display area.

Use the arrow keys to move the drawings of the profiles. Use the "+" and "-" keys of the keyboard to enlarge or reduce the drawings of the profiles.

Optimum area

It selects the best display area, i.e. it places the profile in the center of the graphics area and selects the best zoom possible to show the whole profile.

Autozoom

When applying Autozoom, every time a new section is inserted which goes beyond the screen, the profile will automatically be centered and zoomed in or out to show the whole profile. This way, it will show the whole profile again.

Validate

It may be used to confirm the changes made.

5.

EDITING-SIMULATION MODE
Profile editor

5.9.9 Work plane definition

The softkey menu of this screen may be used to modify the axes of the plane and their directions.

When accessing the plane menu, the softkey menu shows the following options:

Abscissa axis

For selecting the abscissa axis among X, Y and Z.

Abscissa direction

For selecting the direction of the abscissa axis between + and -.

Ordinate axis

For selecting the ordinate axis among X, Y and Z.

Ordinate direction

For selecting the direction of the ordinate axis between + and -.

Validate

It may be used to confirm the changes made.

5.**EDITING-SIMULATION MODE**
Profile editor**FAGOR** **CNC 8070**

(SOFT V02.0x)

5.9.10 End

It ends the profile editing session. When selecting this option, the softkey menu shows the following options.

Save profile

It inserts the profile in the program and exits the profile editor.

Do not save profile

It does not insert the profile in the program and it exits the profile editor.

Continue

It does not insert the profile in the program and it goes on editing profile.

If the profile has been resolved, the CNC will insert it in the part program that is being edited. If the profile cannot be resolved due to lack of data, the CNC will issue the relevant message.

5.

EDITING-SIMULATION MODE
Profile editor

5.9.11 Profile editor. Example 1

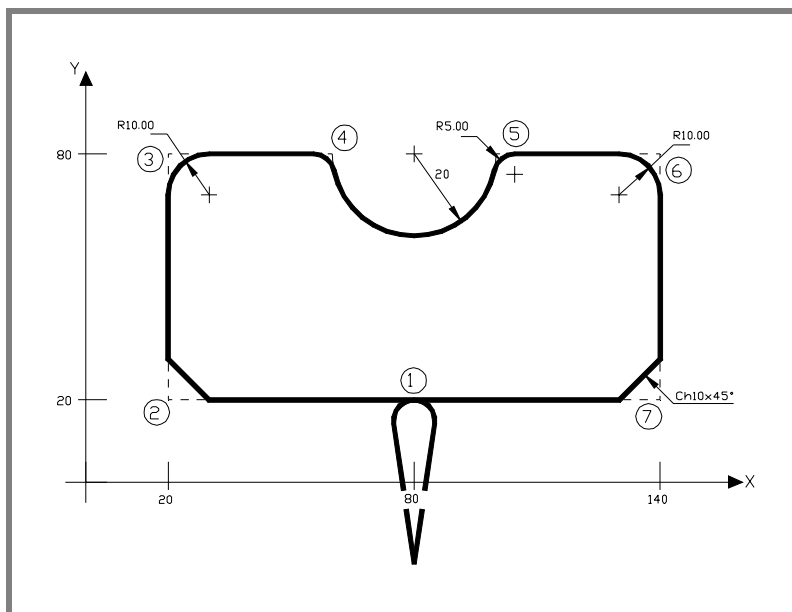

Profile definition without rounding, chamfers or tangential entries and exits.

- Starting point X = 80 Y = -20
- Straight X = 80 Y = 20
- Straight X = 20 Y = 20
- Straight X = 20 Y = 80
- Straight X = 60 Y = 80
- Counterclockwise arc X = 100 Y = 80 Center X = 80 Center Y = 80 Radius = 20
- Straight X = 140 Y = 80
- Straight X = 140 Y = 20
- Straight X = 80 Y = 20
- Straight X = 80 Y = -20

Definition of rounding, chamfers and tangential entries and exits

Select the "CORNERS" option and define:

- | | | | |
|------------------|------------------|--------------------|---------------|
| Tangential entry | Select point "1" | Assign radius = 5 | Press [ENTER] |
| Chamfer | Select point "2" | Assign size = 10 | Press [ENTER] |
| Rounding | Select point "3" | Assign radius = 10 | Press [ENTER] |
| Rounding | Select point "4" | Assign radius = 5 | Press [ENTER] |
| Rounding | Select point "5" | Assign radius = 5 | Press [ENTER] |
| Rounding | Select point "6" | Assign radius = 10 | Press [ENTER] |
| Chamfer | Select point "7" | Assign size = 10 | Press [ENTER] |
| Tangential exit | Select point "1" | Assign radius = 5 | Press [ENTER] |

Press [ESC] to quit the "CORNER" option.

End of editing

Select the "END" option and save the profile. The CNC quits the profile editor and inserts the profile in the part-program.

5.

EDITING-SIMULATION MODE
Profile editor



CNC 8070

(SOFT V02.0x)

5.9.12 Profile editor. Example 2

5.

EDITING-SIMULATION MODE
Profile editor

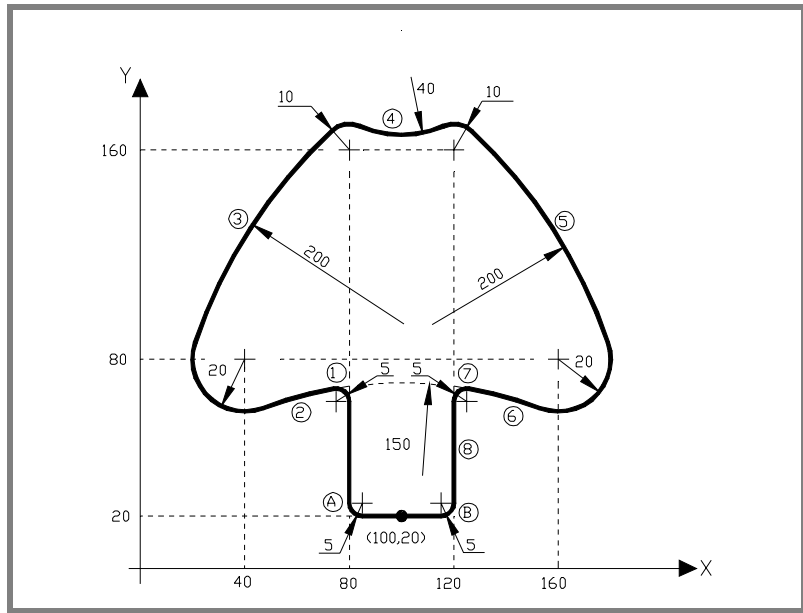

Definition of a profile without rounding.

- | | | | |
|---|----------------|----------------|----------------------------|
| Starting point | X = 100 | Y = 20 | |
| Straight | X = 80 | Y = 20 | |
| Straight | X = 80 | Angle = 90 | |
| CCW arc (1) | Center X = 75 | Radius = 5 | Tangency = Yes |
| CCW arc (2) | Center X = 100 | Radius = 150 | Tangency = Yes |
| Clockwise arc | Center X = 40 | Center Y = 80 | Radius = 20 Tangency = Yes |
| <i>The CNC shows the options for section 2. Select the correct one.</i> | | | |
| <i>The CNC shows the options for section 1. Select the correct one.</i> | | | |
| Clockwise arc (3) | Radius = 200 | Tangency = Yes | |
| Clockwise arc | Center X = 80 | Center Y = 160 | Radius = 10 Tangency = Yes |
| <i>The CNC shows the options for section 3. Select the correct one.</i> | | | |
| CCW arc (4) | Radius = 40 | Tangency = Yes | |
| Clockwise arc | Center X = 120 | Center Y = 160 | Radius = 10 Tangency = Yes |
| <i>The CNC shows the options for section 4. Select the correct one.</i> | | | |
| Clockwise arc (5) | Radius = 200 | Tangency = Yes | |
| Clockwise arc | Center X = 160 | Center Y = 80 | Radius = 20 Tangency = Yes |
| <i>The CNC shows the options for section 5. Select the correct one.</i> | | | |
| CCW arc (6) | Center X = 100 | Radius = 150 | Tangency = Yes |
| <i>The CNC shows the options for section 6. Select the correct one.</i> | | | |
| CCW arc (7) | Center X = 125 | Radius = 5 | Tangency = Yes |
| <i>The CNC shows the options for section 7. Select the correct one.</i> | | | |
| Straight (8) | X = 120 | Y = 20 | Tangency = Yes |
| <i>The CNC shows the options for section 8. Select the correct one.</i> | | | |
| Straight | X = 100 | Y = 20 | |

Rounding definition "A" and "B".

Select the "CORNERS" option and define:

- | | | | |
|----------|------------------|-------------------|---------------|
| Rounding | Select point "A" | Assign radius = 5 | Press [ENTER] |
| Rounding | Select point "B" | Assign radius = 5 | Press [ENTER] |

Press [ESC] to quit the "CORNER" option.

End of editing

Select the "END" option and save the profile. The CNC quits the profile editor and inserts the profile in the part-program.



CNC 8070

(SOFT V02.0x)

5.9.13 Profile editor. Example 3

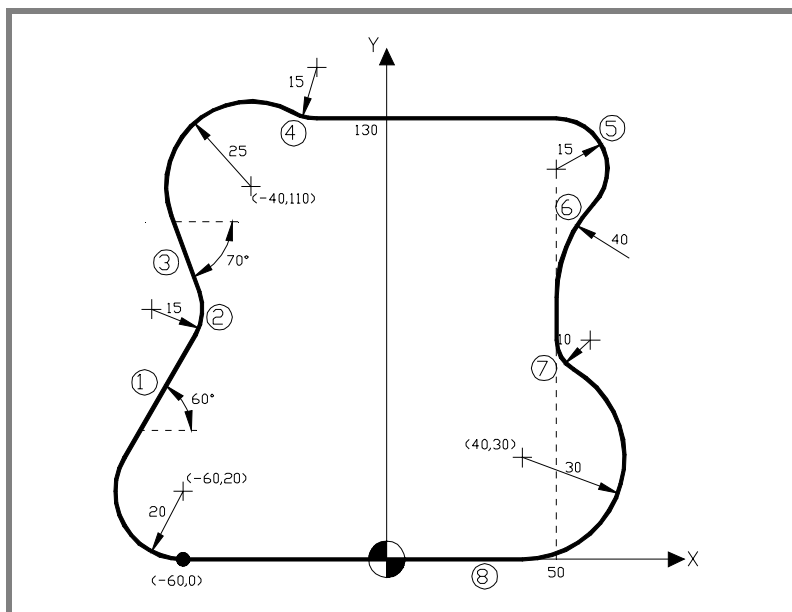

Profile definition.

- Starting point X = -60 Y = 0
- Clockwise arc Center X = -60 Center Y = 20 Radius = 20
- Straight (1) Angle = 60 Tangency = Yes
The CNC shows the options for section 1. Select the correct one.
- CCW arc (2) Radius = 15 Tangency = Yes
- Straight (3) Angle = -70 Tangency = Yes
- Clockwise arc Center X = -40 Center Y = 110 Radius = 25 Tangency = Yes
The CNC shows the options for section 3. Select the correct one.
- CCW arc (4) Radius = 15 Tangency = Yes
- Straight Y = 130 Angle = 0 Tangency = Yes
The CNC shows the options for section 4. Select the correct one.
- Clockwise arc (5) Center X = 50 Radius = 15 Tangency = Yes
The CNC shows the options for section 5. Select the correct one.
- CCW arc (6) Radius = 40 Tangency = Yes
- Straight X = 50 Angle = 270 Tangency = Yes
The CNC shows the options for section 6. Select the correct one.
- CCW arc (7) Radius = 10 Tangency = Yes
- Clockwise arc Center X = 40 Center Y = 30 Radius = 30 Tangency = Yes
The CNC shows the options for section 7. Select the correct one.
- Straight (8) X = -60 Y = 0 Tangency = Yes
The CNC shows the options for section 8. Select the correct one.

End of editing

Select the "END" option and save the profile. The CNC quits the profile editor and inserts the profile in the part-program.

5.

EDITING-SIMULATION MODE
 Profile editor



CNC 8070

(SOFT V02.0x)

5.

EDITING-SIMULATION MODE

Profile editor



CNC 8070

(SOFT V02.0x)

▼ MDI mode selection



The MDI mode may be accessed from any other operating mode, except when a program is in execution (even it is interrupted) by pressing its relevant key.

This work mode may be accessed from any channel. The blocks are executed in the active channel.

The MDI mode lays over all the other work modes in such a way that when quitting the MDI mode by pressing [ESC], the CNC goes into the work mode from where the MDI mode was accessed.

▼ Operations in MDI mode

The following operations are possible in this work mode:

- Edit and execute individual blocks.
- Save the set of blocks executed as an independent program.

6.1 Appearance of the MDI mode

When this operating mode is active, it will be indicated at the top right side of the general status bar.

This mode may be displayed with several screens. The current screen and the total number of available screens are shown at the upper right hand side of the general status bar.

Switching between the different screens is done by pressing the MDI mode accessing key. The screen selection is rotary in such a way that when pressing this key on the last screen, it shows the first one of the operating mode.

Standard configuration

The standard configuration of this work mode, described in this manual corresponds to the one supplied by Fagor. In some cases, the manual shows a sample screen, instead of that of the CNC in order to make it easier to understand.

These screens may be customized by the machine manufacturer changing its contents as well as its appearance. They may also remove certain screens or add some of their own.

6.

MDI MODE
Appearance of the MDI mode



CNC 8070

(SOFT V02.0x)

6.1.1 Window description

As mentioned earlier, the MDI mode may be displayed with two different windows (later sections of this chapter describe how to use them).

Standard window

The standard window only displays one edit line for editing new blocks.

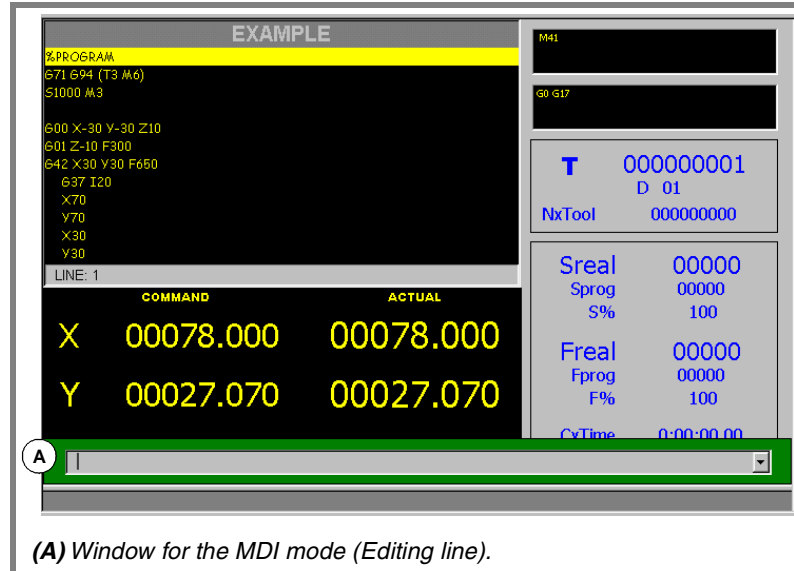

(A) Window for the MDI mode (Editing line).

Full screen

The full screen shows the blocks saved so far and an edit line for editing new blocks.

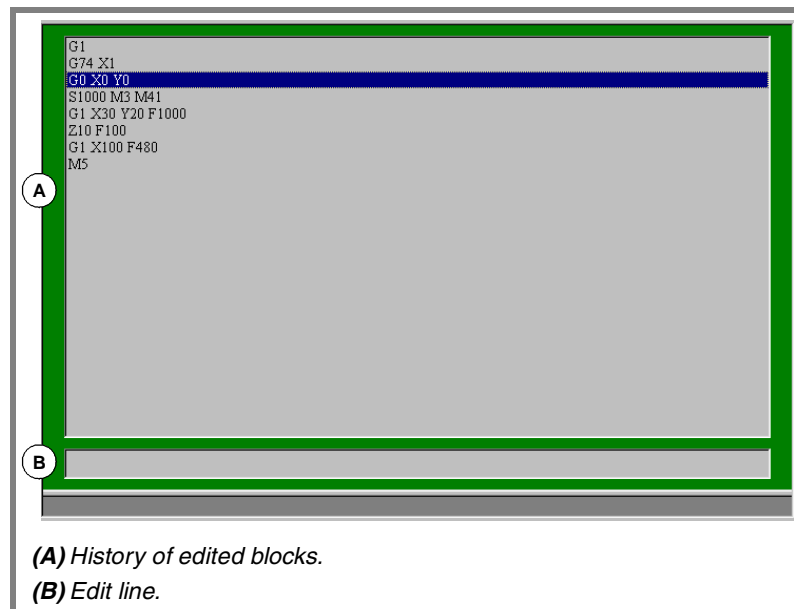

(A) History of edited blocks.

(B) Edit line.

6.

MDI MODE
Appearance of the MDI mode

6.2 Standard MDI window

This window only shows the edit line of the MDI mode.

It is possible to edit and execute new blocks or recover blocks saved in the block history, which may be modified before executing them.

6.

MDI MODE
 Standard MDI window

Description

The standard MDI mode window shows the following information:

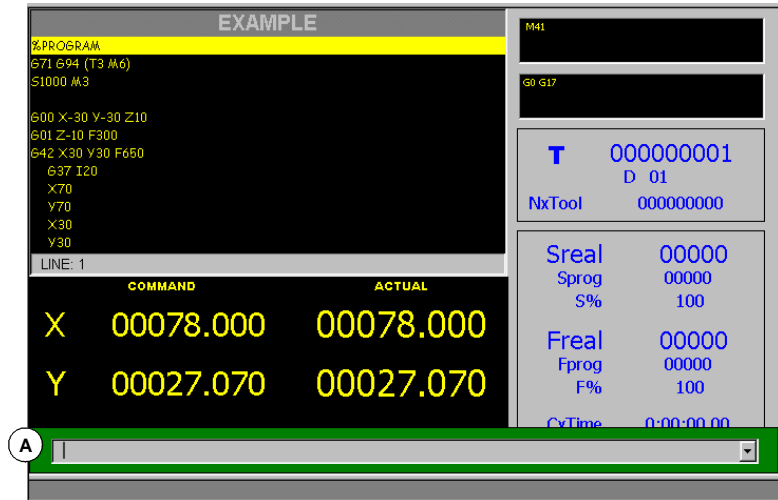

A. Window for the MDI mode (Editing line).

Window where the blocks to be executed are edited. Blocks are edited one by one.





6.2.1 Block editing and execution

In this window, it is possible to edit and execute new blocks or the ones saved in the block history. Only the blocks previously executed will be saved in the block history.

While editing, it analyzes the syntax of the block being edited. When trying to execute, if the block is incorrect, it shows a warning message and it does not execute it.

Editing

The blocks may be edited directly on the edit line or may be recalled from the block history.

Keys for selecting a block from history	
 	To access the history and select a block.
	To accept the selection and show the block on the edit line.
	To cancel the selection and quit the MDI mode.

The recalled blocks may be modified before executing them as if they were new ones.

Execution

The block on the edit line is executed by pressing [START] at the operator panel. Once the block has been executed is saved in the block history.

The [STOP] key interrupts the execution of the block. Press [START] again to resume execution from where it was interrupted.

The [RESET] key cancels the execution of the block and resets the CNC to its initial conditions.

6.

MDI MODE

Standard MDI window

6.3 Full MDI screen

This window shows the blocks saved so far and the edit line of the MDI mode.

It is possible to edit and execute new blocks or recover blocks saved in the block history, which may be modified before executing them.

Description

The full MDI mode screen shows the following information:



A. History of edited blocks.

The block history shows a list of the blocks edited in MDI mode. Every time a new block is edited, it is added to this history.

B. Edit line.

The blocks to be executed are edited on the edit line. Blocks are edited one by one.

Softkey menu

When selecting the full screen, the horizontal softkeys show the options related to this window.

The options available in the softkeys menu are:

□ "New block"

It positions the cursor on the edit line.

□ "Modify"

Recovers the block selected by the cursor and it displays it on the edit line.

This option is the same as pressing [ENTER].

6.

MDI MODE
Full MDI screen

- "Delete"
It deletes the block selected by the cursor.
- "Cancel edit"
It cancels the editing of the block and it shows an empty edit line.
This option is only available when editing a block.
- "Delete all"
It deletes all the blocks from the block history.
- "Save"
It saves all the history blocks as an independent program.

6.
MDI MODE
Full MDI screen



CNC 8070





(SOFT V02.0x)

6.3.1 Block execution

In this window, it is possible to edit and execute new blocks or the ones saved in the block history.

Editing

The blocks may be edited directly on the edit line or may be recalled from the block history.

Keys for selecting a block from history	
 	To access the history and select a block.
	To accept the selection and show the block on the edit line.
	To cancel the selection and quit the MDI mode.

The recalled blocks may be modified before executing them as if they were new ones.

The blocks edited or modified appearing on the edit line may be executed or saved in the block history.

Saving a block

Press [ENTER] to save a block in the history without executing it.

If it is a new block, it will be added to the history whereas if it is modified block, it will replace the previous one in the history.

Block execution





The block on the edit line is executed by pressing [START] at the operator panel. Once the block has been executed is saved in the block history.

The [STOP] key interrupts the execution of the block. Press [START] again to resume execution from where it was interrupted.

The [RESET] key cancels the execution of the block and resets the CNC to its initial conditions.

6.3.2 Save the blocks as a program

To save the block history as an independent program, press the "Save" softkey and the CNC will show a list of the programs saved at the CNC.

Keys for selecting a program	
	To switch windows.
	To move the cursor thru the elements of the window.
	To save the new program.
	To cancel the selection and close the program listing.

To save the program:

1. Write the program name in the bottom window. To replace an existing program, select it from the list.
2. Press [ENTER] to save the program or [ESC] to return to the MDI mode without saving the program.

6.

MDI MODE
Full MDI screen

6.

MDI MODE

Full MDI screen



CNC 8070

(SOFT V02.0x)

▼ User table selection



The CNC tables may be accessed from any other operating mode, even while a program is in execution, by pressing the key for these tables.

The user tables consist of the following tables:

- Zero offset table.
- Clamp tables (fixtures).
- Table of arithmetic parameters, global, local and common.

In order to activate a fixture zero or part zero offset, those values must be previously stored in the relevant CNC table.

▼ What can you do in this work mode?

The following operations are possible in this work mode:

- Edit and modify the tables for zero offsets and parameters.
- Save the content of a table.
- Recover the content of a table.
- Print the content of a table.
- Initialize a table.

7.1 Appearance of the table mode

7.

USER TABLES

Appearance of the table mode

This operating mode consists of several tables. The various tables may be selected using the horizontal softkeys.

Some tables are common to all the channels and others belong to each channel. In this case, by default, they show the ones of the active channel; but it is possible to access those of any other channel from the vertical softkey menu.

The zero offset tables and fixture offset tables are common to all the channels; however, in each channel they show the axes of that channel. When applying an offset in a channel, it is only applied to the axes that are part of the channel at the time.

The tables available are:

- Zero offset table.
- Fixture table.
- Table of global parameters. There is a table for each channel.
- Table of local parameters. There are seven tables for each channel, one table per level.
- Table of common parameters. The table is common to all the channels.

Standard configuration

The standard configuration of this work mode, described in this manual corresponds to the one supplied by Fagor. In some cases, the manual shows a sample screen, instead of that of the CNC in order to make it easier to understand.

7.1.1 Icon description (vertical softkeys)

The icons are activated with their associated softkey (F8 to F12).



The icon menu offers all the options for the selected table. The group of icons of this menu may be expanded with the softkey associated with the "+" icon that offers a new set of icons.

List of icons



Display units (millimeters/inches)

To toggle the units for the position of the linear axes. Toggling these units does not affect the rotary axes which will always be displayed in degrees.

The icon highlights the units currently selected (millimeters or inches).

It must be borne in mind that the unit change is only valid for display and data entry. A program assumes the units defined with the active function "G70" or "G71", or, when not programmed, the units set by the machine manufacturer.



Initialize table

Resets all the table data to "0". The CNC will request confirmation of the command.



Find text

It is used to find a text or a value in the table.

When selecting this option, the CNC shows a dialog box requesting the text to be found.

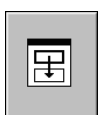

Accessing the tables of other channels

(This icon will only be available when using channels).

Some tables only show the data of the active channel. This icon gives access to the tables of the other channels.



Select axes

It may be used to select the axes to be displayed in the tables.

When using several channels, only those axes assigned to the active channel may be accessed.



Save tool

It saves the values of the table into a file. This file may be saved at the CNC, in a floppy disk or at another CNC (or PC) connected through Ethernet.

7.

USER TABLES

Appearance of the table mode

FAGOR 

CNC 8070

(SOFT V02.0x)

7.

USER TABLES

Appearance of the table mode



Recall table

It restores the values of the table previously saved into a file.



Print table

It prints the contents of the table out to a printer connected to the CNC or as a file (*.PRN format) at the CNC.

7.2 Zero offset tables

This table stores the zero offsets for each axis. There are up to 20 absolute zero offsets and a special one for the PLC.

Although the table is common to all the channels, when accessing from a channel, it only shows the axes of that channel. The offsets of other channels may be accessed from the vertical softkey menu.

ZERO OFFSETS				
Origin	X (mm)	Y (mm)	Z (mm)	A (deg.)
PLCOF	00000.000	00000.000	00000.000	00000.000
G54	00000.000	00000.000	00000.000	00000.000
G55	00000.000	00000.000	00000.000	00000.000
G56	00000.000	00000.000	00000.000	00000.000
G57	00000.000	00000.000	00000.000	00000.000
G58	00000.000	00000.000	00000.000	00000.000
G59	00000.000	00000.000	00000.000	00000.000
G159=7	00000.000	00000.000	00000.000	00000.000
G159=8	00000.000	00000.000	00000.000	00000.000
G159=9	00000.000	00000.000	00000.000	00000.000
G159=10	00000.000	00000.000	00000.000	00000.000
G159=11	00000.000	00000.000	00000.000	00000.000
G159=12	00000.000	00000.000	00000.000	00000.000
G159=13	00000.000	00000.000	00000.000	00000.000
G159=14	00000.000	00000.000	00000.000	00000.000
G159=15	00000.000	00000.000	00000.000	00000.000

- A. Machine axes and display units (millimeters, inches or degrees).
- B. Zero offsets.
- C. Zero offset value in each axes of the channel.

The end of this chapter describes how to edit this table.

PLC offset

It cannot be directly defined in the table. The values are set from the PLC or from the part-program using high-level variables.

It is used, for example, to correct deviations originated by machine dilatations.

The CNC always adds the PLC offset to the selected zero offset.

7.

USER TABLES
Zero offset tables



CNC 8070

(SOFT V02.0x)

7.

USER TABLES

Zero offset tables

Absolute zero offsets

Besides setting the values directly in the table, they may also be set from the PLC or via part-program using high-level variables.

The zero offsets are used to place the part zero at different positions of the machine. When applying a zero offset, the CNC assumes as the new part zero the point set by the selected zero offset referred to the clamp zero (if active).

To apply an absolute zero offset, it must be activated via program using the relevant function.

7.3 Fixture table

This table stores the clamp offsets for each axis. There are up to 10 clamp offsets.

Although the table is common to all the channels, when accessing from a channel, it only shows the axes of that channel. The offsets of other channels may be accessed from the vertical softkey menu.

FIXTURE OFFSETS				
Fixture	X (mm)	Y (mm)	Z (mm)	A (deg.)
1	00000.000	00000.000	00000.000	00000.000
2	00000.000	00000.000	00000.000	00000.000
3	00000.000	00000.000	00000.000	00000.000
4	00000.000	00000.000	00000.000	00000.000
5	00000.000	00000.000	00000.000	00000.000
6	00000.000	00000.000	00000.000	00000.000
7	00000.000	00000.000	00000.000	00000.000
8	00000.000	00000.000	00000.000	00000.000
9	00000.000	00000.000	00000.000	00000.000
10	00000.000	00000.000	00000.000	00000.000

- A. Machine axes and display units (millimeters, inches or degrees).
- B. Clamp offset.
- C. Clamp offset value in each axes of the channel.

The end of this chapter describes how to edit this table.

Fixture offset

Besides setting the values directly in the table, they may also be set from the PLC or via part-program using high-level variables.

The clamp offsets are used to set the position of the clamping system of the machine. When applying a clamp offset, the CNC assumes as new clamp zero the point set by the selected offset referred to machine reference zero (home).

To apply a clamp offset it must be activated from the program using the relevant variable.



7.4 Arithmetic parameter tables

7.

USER TABLES
Arithmetic parameter tables

There are the following arithmetic parameter tables:

- Common parameters.
- Global parameters.

There is a table for each channel.

- Local parameters.

There are seven tables for each channel, one table per nesting level (7 levels).

The CNC generates a new nesting level for local parameters every time parameters are assigned to a subroutine.

GLOBAL P PARAMETERS	
Parameter	Value
P100	101.980390
P101	100.000000
P102	20.000000
P103	1.164153E-014
P104	1.164153E-014
P105	0
P106	0
P107	0
P108	0
P109	0
P110	0
P111	0
P112	0
P113	0
P114	0
P115	0

A. Parameter list.

B. Parameter value.

The end of this chapter describes how to edit these tables.

Arithmetic parameters

The OEM defines the range of local and global parameters up to a maximum of 100 local parameters (P0-P99) and 9900 global parameters (P100-P9999).

When the local parameters are used in a subroutine calling block, they can also be referred to by the letters A-Z (except "Ñ") in such a way that "A" is the same as P0 and "Z" is the same as P25. That is why the local parameter tables show the parameter number next to their associated letter.

The parameter values may be set directly in the table or from the PLC or via part-program. In this case, the table values are updated after carrying out the operations indicated in the block being executed.

The parameter values may be displayed either in decimal notation (6475.873) or scientific (0.654E-3).













CNC 8070

(SOFT V02.0x)

7.5 Operations with tables

7.5.1 Data editing

Select the desired table using the softkey menu:

Keys for editing the table data	
	<i>To move the cursor through the table cells.</i>
  	
 	<i>To move the cursor page by page.</i>
 	<i>To move the cursor to the beginning or end of the table.</i>
	<i>To validate the new value.</i>
	<i>To ignore the defined value.</i>

To edit the table data, proceed as follows:

1. Use the cursor to select the cell whose value is to be changed.
2. Key in the new value.
3. Press [ENTER] to accept the new value or [ESC] to ignore the new value and recover the previous one.

7.

USER TABLES
Operations with tables

7.5.2 Save and recall tables

7.

USER TABLES
Operations with tables

Saving a table

It may be used to save the table data, in ASCII format, in a file.



After selecting the table whose data is to be saved, press the SAVE icon and the CNC shows a list with the tables that are already saved.

Keys for selecting a data file	
	To switch windows.
	To close and open a folder submenu.
	To move the cursor thru the elements of the window.
	To save the new program.
	To cancel the selection and close the programs listing.

To save the table data, proceed as follows:

1. Select the destination folder.
2. Define the file name at the bottom window. To replace an existing file, select it from the list.
3. Press [ENTER] to save the file or [ESC] to return to the table without saving the file.

Depending on the table being saved, the CNC will assign one of the following extensions to the file:

- *.UPO Zero offset table.
- *.UPF Fixture table.
- *.UPP Parameter tables.

Recall a table

It may be used to restore the table data, in ASCII format, from a file.



After selecting the table whose data is to be restored, press the LOAD icon and the CNC shows a list with the tables that are already saved.

To recover the table data, proceed as follows:

1. Select the folder containing the file.
2. Select the file from the list or write its name in the bottom window.
3. Press [ENTER] to recall the data from the file or [ESC] to return to the table without recalling the data.

7.5.3 Find text

It is used to find text or a value in the table.

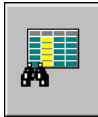

To perform the search, press the FIND icon and the CNC will show a dialog box requesting the text or value to be searched. It is also possible to select whether the search must start at the beginning of the table or at the current cursor position.

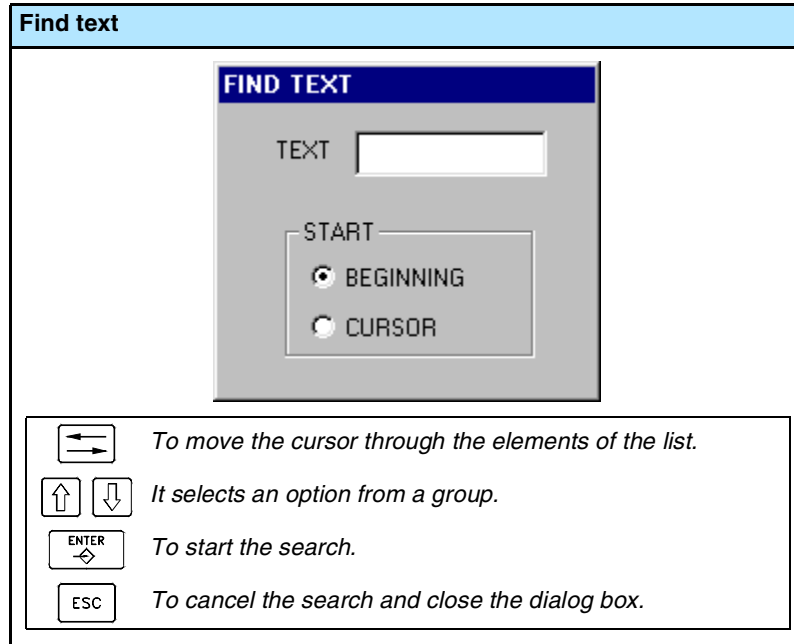

To start the search, press [ENTER] and the cursor will position on the text found. Pressing this FIND icon again will allow repeating the search or defining a new one.

7.

USER TABLES
Operations with tables

7.

USER TABLES

Operations with tables



CNC 8070

(SOFT V02.0x)

▼ Selecting the tool tables and magazine tables.



The CNC tables may be accessed from any other operating mode, even while a program is in execution, by pressing the key for these tables.

They may be divided into the following tables:

- Tool table.
- Active-tools table.
- Tool magazine tables.

In order to load a tool in the magazine or in the spindle, that tool must have been previously defined in the corresponding table of the CNC.

▼ What can you do in this work mode?

The following operations are possible in this work mode:

- Editing and modifying the tool table
- Display and manage the tool arrangement in the magazines and in the tool changing arms (if any).
- Display the information about the tool change process; the operation carried out when executing an M06, manager status, change status (in execution or at rest), magazine involved in the change (if the change is taking place) and whether the change process is or not in an error state.
- Load and unload a tool from the magazines through the spindle, using a maneuver.
- Saving the table contents.
- Recalling the table contents.
- Printing the table contents.
- Initializing the tables.

8.1 Appearance of the tables associated with the tools and the tool magazines.

This operating mode consists of several tables. The various tables may be selected using the horizontal softkeys.



If while one of the tables is selected, the previous menu key is pressed, that table will be deselected. This offers the possibility to save and restore all the tables.

The tables available are:

- Tool table. The table is common to all the tool magazines.
- Active-tools table.
- Magazine table. There is a table for each magazine.

Standard configuration

The standard configuration of this work mode, described in this manual corresponds to the one supplied by Fagor. In some cases, the manual shows a sample screen, instead of that of the CNC in order to make it easier to understand.

8.

TOOL AND MAGAZINE TABLE
Appearance of the tables associated with the tools and the tool magazines.

8.1.1 Table selection

When accessing this work mode, the horizontal softkey menu shows all the tables related to this work mode: Tools, active tools and magazine.

□ Tool table

This table defines the tools available and the data associated with each one of them.

□ Active-tools table

This table shows the tool located in each spindle and the data associated with it.

□ Magazine table

There is a table per magazine. These tables show the tool lay out in the magazine and which tool is located in the spindle and on the changer arm (if any).

Pressing the key for the previous menu deselects the active table.

Icons associated with the tables

When selecting one of the tables, it will be displayed on the screen and the vertical icon menu will show the icons related to that table (later sections of this chapter will describe in further detail the icons related to each table).

If no table is currently selected, the vertical icon menu will show the following icons that are valid for all the tables.



Save the tables

Saves the data of all the tables. The data may be stored at the CNC, in a floppy disk or at another CNC (or PC) connected through Ethernet.



Recall the tables

It restores the data previously saved for all the tables.

8.

TOOL AND MAGAZINE TABLE
Appearance of the tables associated with the tools and the tool magazines.

8.1.2 Save and load the tables

8.

TOOL AND MAGAZINE TABLE

Appearance of the tables associated with the tools and the tool magazines.

Save the tables

It may be used to save the data, in ASCII format, of the tables in files. These tables are saved in the following files.

Tools.TPT	Tool table.
Toolsact.TPA	Active-tools table.
Magazine.TPM	Magazine table



When pressing the SAVE icon, the CNC will show a list of the tables that are stored.

Keys for selecting a data file	
	To switch windows.
	To close and open a folder submenu.
	To move the cursor thru the elements of the window.
	To save the new program.
	To cancel the selection and close the programs listing.

To save the table data, proceed as follows:

1. Select the folder for saving the data files. By default, they are saved in "C:\CNC8070\MTB\DATA" or in the last directory selected by the user.
2. Press [ENTER] to save the file or [ESC] to return to the table without saving the file.

Recall the tables

It may be used to restore the data, in ASCII format, of the tables from the files.



When pressing the LOAD icon, the CNC will show a list of the tables that are stored.

To recover the table data, proceed as follows:

1. Select the folder that contains the files. By default, they are saved in "C:\CNC8070\MTB\DATA" or in the last directory selected by the user.
2. Press [ENTER] to load the table data or [ESC] to return to the table without loading the data.

Order (sequence) to follow when loading the different tables.

There are two ways to load the table data from the ASCII files; loading all of them at the same time or selecting each table and loading its data.

Loading all the tables at the same time.

This operation may be carried out when no table has been selected. In this case, it is up to the CNC to set the order (sequence) used to load the data.

Order (sequence) to follow when loading the tables one by one.

This way, each table is selected and its data loaded. In this case, the following sequence must be followed when loading the tables.

1. First load the tool table. This defines the tools of the system.
2. Second, load the tool magazine tables. Otherwise, it is unsure that the tools loaded earlier will be the ones located in the active tool magazine or in the active tool tables.
3. Finally, load the active-tools table. When loading the magazine tables, it is unsure that the current tool positions will be compatible with the active tools.



TOOL AND MAGAZINE TABLE
 Appearance of the tables associated with the tools and the tool magazines.



CNC 8070

(SOFT V02.0x)

8.2 Tool table

This table defines the tools available and the data associated with each one of them.

8.
TOOL AND MAGAZINE TABLE
Tool table

The screenshot shows a software interface for tool management. On the left, a table lists 15 tools. On the right, a detailed view for 'TOOL 4' is shown, including fields for Number, Name, Family, Offse. Count, Status, Geometry (mm), Type, Subtype, Length, Radius, Rp, Lc, L Wear, R Wear, Rp Wear, Entry angle, Monitoring Type, Maximum life, Real life, Magazine Size, Positions to the left, Positions to the right, and a Comment field.

Tool	Name	Position
1	ENDMILL	1-M1
2	ENDMILL	1-M2
3	ENDMILL	C1
4	ENDMILL	5-M1
5	ENDMILL	2-M2
6	ENDMILL	
7	ENDMILL	11-M1
8	BORE	CH1-M2
9	REAMER	
10	TAP M10	3-M2
11	DRILL 4.5	
12	DRILL 8.5	C2
13	DRILL 10	14-M1
14	DRILL 20	6-M2
15	ENDMILL	

(A) Tool listing.
(B) Tool description.



The table is divided in two windows. To switch windows, press the relevant key.

Tool listing

It shows the list of available tools and their position. The CNC updates data of the list every time a tool change is carried out.

Keys to select a tool from the list		
		To scroll list up and down line by line.
		To move the cursor page by page through the list.
		To move the cursor to the beginning or end of the list.
		To access the data of the selected tool.

Tool number

It is assigned automatically when the tool is added to the list. It may be modified by the user in the data window.

Tool name

Name identifying the tool defined by the user in the data window. It may be edited directly on the list.

Tool position

It indicates the position of the tool, in a magazine, in the spindle or in the claws of the tool changer arm.

- C1-C4 It is in one of the spindles.
- M1-M4 It is in one of the magazines. In this case, it also indicates its magazine position.
- CH1-CH2 It is in the holders of the tool changer arm.





If none of these positions is indicated, it means that it is a ground tool. Ground tools are not stored in the magazine and are loaded manually when requested.



TOOL AND MAGAZINE TABLE
Tool table

Tool data

It shows the tool data defined by the user. See ["8.2.3 Description of the tool table data"](#) en la página 185.

Keys for selecting the table data	
 	<i>It selects the previous and next data of the same group.</i>
 	<i>It selects the first data of the previous or next group.</i>

The tool data is grouped as follows:

Tool identification

Information identifying the tool: number, name, family, number of tool offsets and status.

Tool geometry

Information about tool type and dimensions.

This data is associated with the tool offset. When the tool has more than one offset associated with it, there will be a group of data for each offset.

Tool monitoring

Information associated with tool life monitoring.

This data is associated with the tool offset. When the tool has more than one offset associated with it, there will be a group of data for each offset.

Magazine

Information about tool size, required to store it in the magazine.

Custom

Data defined by the manufacturer.

Comment



CNC 8070

(SOFT V02.0x)

8.2.1 Icon description (vertical softkeys)

The icons are activated with their associated softkey (F8 to F12).



The icon menu offers all the options for the selected window. The group of icons of this menu may be expanded with the softkey associated with the "+" icon that offers a new set of icons.

List of icons



Display units (millimeters/inches)

It is used to change the units for data display.

The icon highlights the units currently selected (millimeters or inches).

It must be borne in mind that the unit change is only valid for display and data entry. For programming, the CNC assumes the units set by the active function G70 or G71.



Find text

It is used to find a text or a value in the table.

When selecting this option, the CNC shows a dialog box requesting the text to be found.

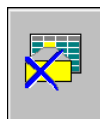

Delete data

(This icon is only available when selecting the window with tool data).

It deletes the data where the cursor is. When deleting a data, it assumes its default value.

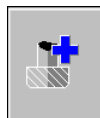

Add tool

(This icon is only available when selecting the window with tool list).

It adds a new tool to the list.



Remove tool

(This icon is only available when selecting the window with tool list and if the tool is not in the magazine).

It removes a tool from the list.



Initialize table

(The table can only be initialized when the CNC is "READY").

It initializes the tool table. Initializing the tables eliminates all the tools from the list.

It also initializes the active-tools table and the magazine tables because the available tools have been erased.

The CNC will request confirmation of the command.

8.

TOOL AND MAGAZINE TABLE
Tool table



Save tool

It saves the table data in a file. This file may be saved at the CNC, in a floppy disk or at another CNC (or PC) connected through Ethernet.



Recall table

(The table can only be initialized when the CNC is "READY").

It recalls the table data previously saved in a file. Bear in mind that loading the tool table initializes the magazine tables and the active-tools table.



Print table

It prints the contents of the table out to a printer connected to the CNC or as a file (*.PRN format) at the CNC.



Configuration

(This icon is only available when selecting the window with tool data).

It is used to configure the data shown in the tool table.



TOOL AND MAGAZINE TABLE
Tool table



CNC 8070





(SOFT V02.0x)

8.2.2 Tool table setting



The information shown in the tool table may be set with the CONFIGURE icon. When pressing this icon, the CNC shows a dialog box for selecting the data to be shown in the tool table. To hide a data in the table, cancel the relevant check box

Keys to set the tool table

		To move the cursor.
		To activate/deactivate the selection box.
		To accept the configuration defined.
		To cancel the defined configuration.

8.

TOOL AND MAGAZINE TABLE

Tool table

8.2.3 Description of the tool table data

Tool

Number (1-999999999)

Tool number. It is assigned automatically when the tool is added to the list.

When is this data modified.

- When entering an existing tool number, the CNC displays the data for that tool.
- When entering a nonexistent tool number, that number will be assigned to the tool selected on the list. The tool number cannot be changed if it is in the magazine, in the spindle or on the tool changer arm.

Name (32 characters)

Name identifying the tool.

Family (0-99999999)

It is used when having an automatic tool changer. It is used to replace the tool worn out or rejected with another one with similar characteristics.

When requesting a new tool, the CNC checks whether it is worn out (real life greater than nominal life) or it has been rejected. If so, it selects the next tool in the table that belongs to the same family.

Offsets (1-8)

Number of tool offsets.

Each tool offset has different geometry and monitory data associated with it.

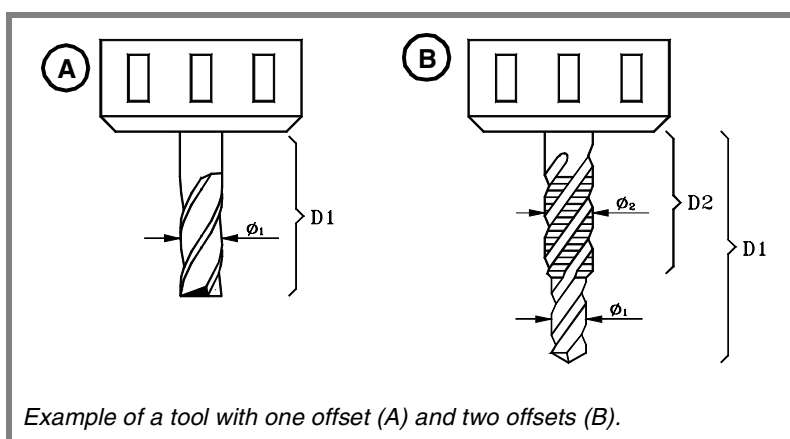

8.

TOOL AND MAGAZINE TABLE
Tool table

FAGOR 

CNC 8070

(SOFT V02.0x)

8.

Status

It indicates the tool status. The possible status are:

Available

Worn out The "real life" is greater than the "nominal life".

Rejected The tool has been rejected by the PLC.

The "Worn out" and "Rejected" indicators are set by the CNC when one of the previous cases occurs.

Geometry

This area shows the data about the type and dimensions of the tool offset. If the tool has been defined with several offsets, it shows the number of the offset whose data is displayed, and it also allows selecting the previous or next offset.

(A) Offset number and selection of the previous or next offset.
 (B) Tool type and subtype.
 (C) Offset geometry.
 (D) Help graphics related to the selected data.

While defining the data, it shows help graphics of the data being defined. The top images show the "type" or "subtype" of the selected tool and the side image shows the rest of the data. On the other hand, the bottom of the screen shows the description of the data currently selected.

The data related to the geometry may be accessed with the following hotkeys:

Hotkey	Access
L	Length, length wear and edge length.
R	Radius, radius wear, nose (tip) radius and nose (tip) radius wear.
A	Penetration angle
O	Offsets on each axis.

Type

Tool type. The available types are:

Milling	Drilling	Surface milling
Reaming	Boring	Tapping
Grooving/cutoff	Turning	Others

Subtype

Tool subtype. The available subtypes are:

Without type	Flat	Round
Toric	Cutter	Tap

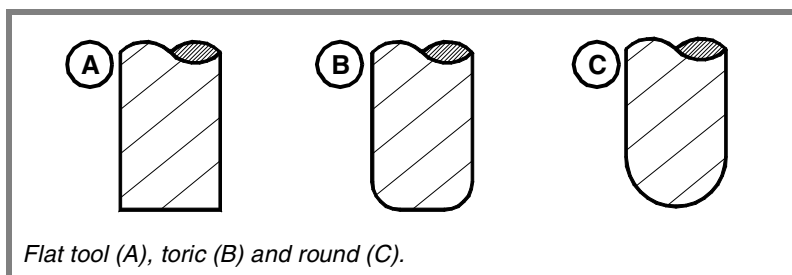

Length

Tool length.

Radius

Tool radius.

L wear

Tool length wear offset.

The CNC will add this value to the nominal length to calculate the real tool length ("Length" + "L wear").

R wear

Tool radius wear offset.

The CNC will add this value to the nominal radius to calculate the actual (real) tool radius ("Radius" + "R wear").

A tool with a radius of 20mm and a length of 134mm has a radius wear of 0.2mm and a length wear of 0.15mm, the tool table should be set as follows:

Radius: 20mm.	R wear: -0.2mm.
Length: 134mm.	L wear: -0.15mm.

*The CNC will assume a real tool radius: $20 + (-0.2) = 19.8\text{mm}$.
and a real tool length: $134 + (-0.15) = 133.85\text{mm}$.*



TOOL AND MAGAZINE TABLE
Tool table



CNC 8070

(SOFT V02.0x)

8.

TOOL AND MAGAZINE TABLE
Tool table

Rp (tool tip radius)

Tool tip radius

Rp wear

Tool tip radius wear.

The CNC will add this value to the nominal tool tip radius to calculate the actual (real) tool tip radius ("Rp" + "Rp wear").

Lc (Cutting length)

Length of the cutting edge of the tool.

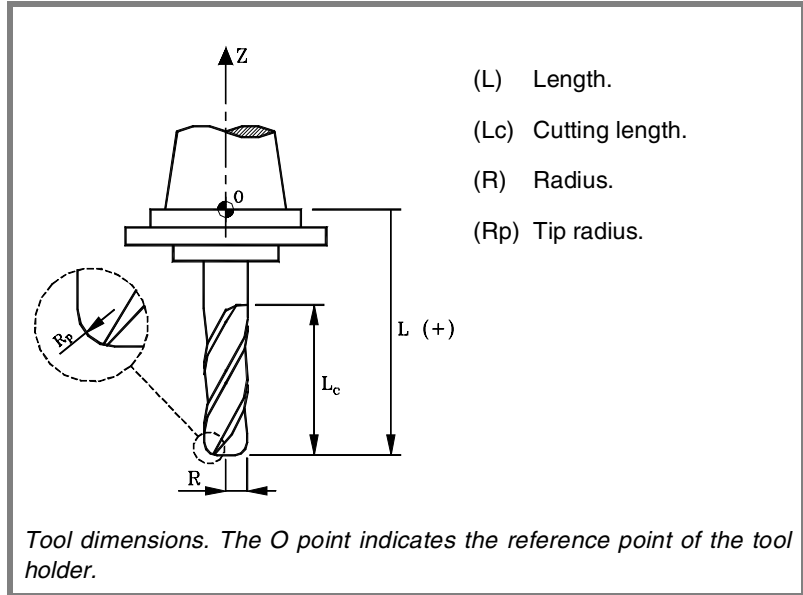

Entry angle

Penetration angle for pocket milling.

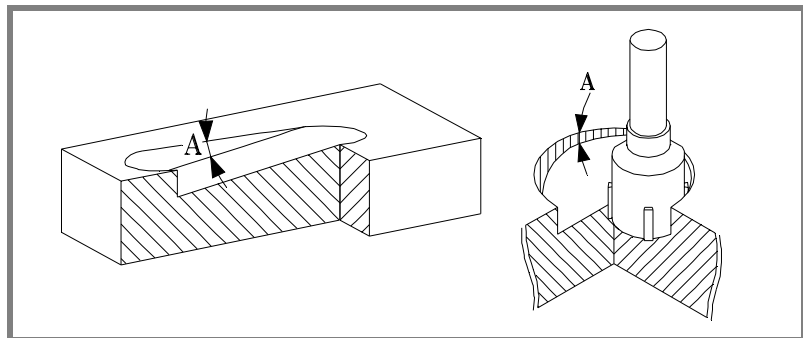

X, Y, Z

Tool offset. It is used to define the tool position when using a tool holder or an intermediate tooling.

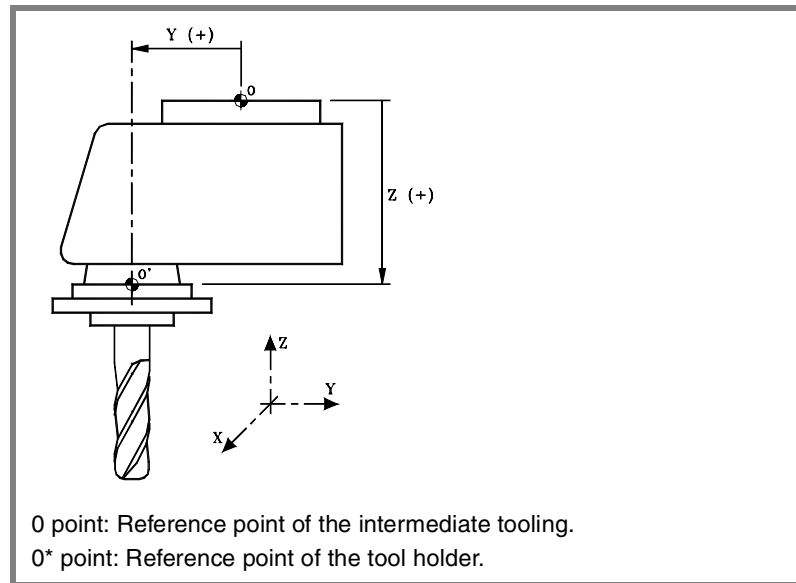

TOOL AND MAGAZINE TABLE
 Tool table

Monitoring

This group shows the data related to tool life monitoring. If a tool has been defined with several offsets, it is possible to manage the status of each one.

When managing the live of two or more offsets of the same tool, the list of the magazine positions (magazine table) only shows whether the tool has been rejected or not.

Type

It is used to activate and select the type of tool life monitoring (in time or number of operations).

Nominal life

Machining time (in minutes) or number of operations that the tool may carry out.

Real (actual) life

Machining time or number of operation the tool has carried out. The CNC updates this value when the tool is being used.



CNC 8070

(SOFT V02.0x)

8.

TOOL AND MAGAZINE TABLE
Tool table

Magazine

This information cannot be modified if the tool is in the spindle, on the changer arm or in the magazine.

Size

Tool size. The size determines the number of positions (pockets) the tool occupies in the magazine.

Positions to the right / Positions to the left

Space reserved for the tool to left and to the right of its position.

- Small: It takes no extra position.
- Medium: It takes half of an additional position to the right and to the left.
- Large: It takes a full additional position to the right and to the left.
- Custom: The user defines the number of additional positions the tool occupies to its right and to its left.

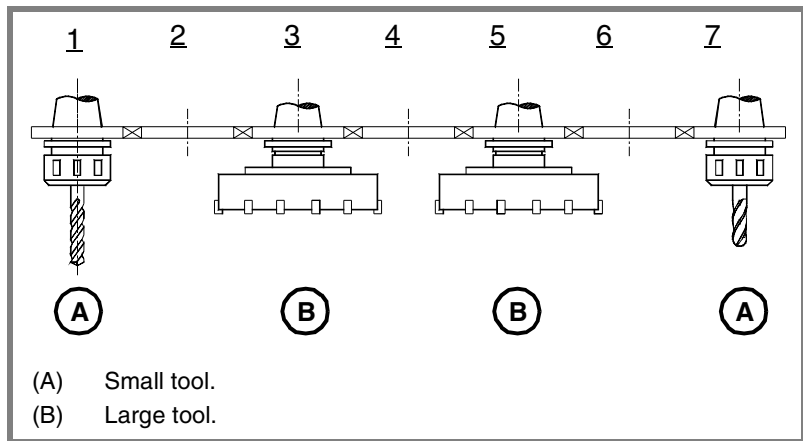

Special

The tool always occupies the same position in the magazine.

Custom

Data 1 / Data 2

These data show, in numerical format, the information selected by the manufacturer.

Data 3 / Data 4

These data show, in binary format, the information selected by the manufacturer.

Comment

Comment associated with the tool.

8.3 Operations with the tool table

8.3.1 Editing the tool table

Adding/removing a tool to/from the list

A tool may be added or deleted only when it is selected on the tool list.

Add a tool to the list.



To add a tool, press the ADD icon. The tool is added to the list at the first free position.

Remove a tool from the list.



To remove a tool from the list, select it on the list and press the DELETE icon. A tool cannot be removed if it is in the magazine, in the spindle or on the tool changer arm.











Data editing

To fill out the tool table data:

1. Select the tool to be set from the list and press [ENTER] to access its data.
2. Configure the table to show only the data that may be defined hiding the rest.
3. Define the tool data. Every time a new value is defined, press [ENTER] to validate it.

If more than one offset is associated with the same tool, select the "more offsets" icon to display the data of the other offsets

4. Make a safety backup copy of the tool data out to a file.

Keys for tool table editing	
 	To move the cursor through the table data.
	To validate the new value.
	To activate/deactivate the selection boxes and open/close drop lists.
 	To move the cursor within a data.
 	To select the line before or after the comment.
 	To move the cursor to the beginning or end of the comment line.

8.

TOOL AND MAGAZINE TABLE
Operations with the tool table

FAGOR 

CNC 8070

(SOFT V02.0x)

Initialize table



The tool table may be reset (initialized) with the INITIALIZE icon. When resetting the table, all the tools are eliminated from the list, including those in the spindle and on the tool changer arm.

The data of the active-tools table and the data of the magazine tables are also erased because the available tools have been erased.

8.

TOOL AND MAGAZINE TABLE
Operations with the tool table

8.3.2 Saving, loading and printing tables

Saving a table

It may be used to save the table data, in ASCII format, in a file.

Together with this table, we recommend to also save the tool magazine tables and the active-tools table, if there is any. If the tool table is loaded later, the rest of the tables will be initialized.



The data of the tool table may be saved into a file with the SAVE icon. When pressing this icon, the CNC shows a list of files already saved.

Keys for selecting a data file	
	To switch windows.
	To close and open a folder submenu.
	To move the cursor thru the elements of the window.
	To save the new program.
	To cancel the selection and close the programs listing.

To save the table data, proceed as follows:

1. Select the folder to save them. By default, they are saved in the folder "C:\CNC8070 \MTB \DATA" or in the last folder selected by the user.
2. Define the file name at the bottom window. To replace an existing file, select it from the list.
3. Press [ENTER] to save the file or [ESC] to return to the table without saving the file.

The tool table data is saved in a file with the extension "TPT".

Loading a table

It may be used to restore the table data, in ASCII format, from a file.

Loading the tool table initializes the magazine tables and the active-tools table. This is because loading the table modifies the list of available tools and it may not be coherent with the arrangement of tools in the magazine and in the spindles. This is why after loading this table it is necessary to define (or load) the magazine tables and the active-tools table, if any, in that order.



The tool table data may be recovered using the LOAD icon. When pressing this icon, the CNC shows a list of files already saved

8.

TOOL AND MAGAZINE TABLE

Operations with the tool table

FAGOR

CNC 8070

(SOFT V02.0x)

8.

TOOL AND MAGAZINE TABLE
Operations with the tool table

To recover the table data, proceed as follows:

1. Select the folder containing the file. By default, they are saved in the folder "C:\CNC8070 \MTB \DATA" or in the last folder selected by the user.
2. Select the file from the list or write its name in the bottom window.
3. Press [ENTER] to recall the data from the file or [ESC] to return to the table without recalling the data.

Print table

The tool table data may be printed to a printer connected to the CNC or to a file (*.PRN format) at the CNC.



To print the table, use the PRINT icon. When pressing this icon, the CNC will show a dialog box requesting the print destination for the table (printer or file).

When printing to a file, it is possible to select the name and location of the file. By default in "C:\Cnc8070 \Users \Reports".

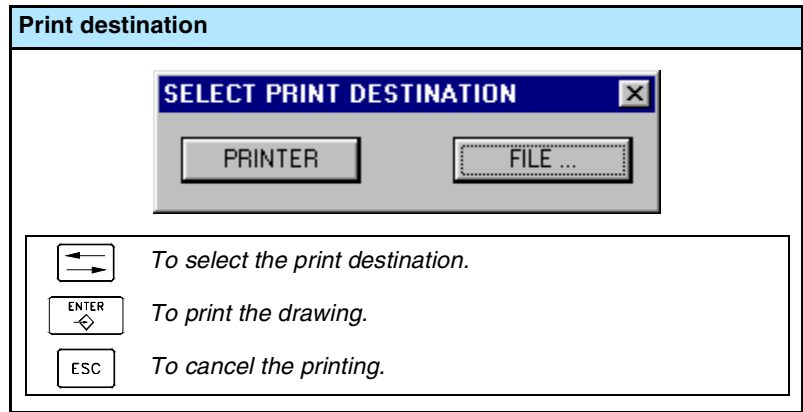

After selecting the destination, press [ENTER] to print the table or [ESC] to cancel it.

8.3.3 Find text

It is used to find text or a value in the table.



To perform the search, press the FIND icon and the CNC will show a dialog box requesting the text or value to be searched. It is also possible to select whether the search must start at the beginning of the table or at the current cursor position.

Find text

FIND TEXT

TEXT

START

BEGINNING

CURSOR

To move the cursor through the elements of the list.

It selects an option from a group.

To start the search.

To cancel the search and close the dialog box.



To start the search, press [ENTER] and the cursor will position on the text found. Pressing this FIND icon again will allow repeating the search or defining a new one.

8.

TOOL AND MAGAZINE TABLE

Operations with the tool table

8.4 Active-tools table

This table shows the list of available tools and which one is active in each channel.

8.
TOOL AND MAGAZINE TABLE
 Active-tools table

TOOLS		
Tool	Name	Position
1	ENDMILL	1-M1
2	ENDMILL	1-M2
3	ENDMILL	C1
4	ENDMILL	5-M1
5	ENDMILL	2-M2
6	ENDMILL	
7	ENDMILL	11-M1
8	BORE	CH1-M2
9	REAMER	
10	TAP M10	3-M2
11	DRILL 4.5	
12	DRILL 8.5	C2
13	DRILL 10	14-M1
14	DRILL 20	6-M2
15	ENDMILL	

(A) Tool listing.

(B) Active tools.

(C) Tool selected on the list.



The table is divided in two windows. To switch windows, press the relevant key.

Tool listing

It shows the list of available tools and their position. The CNC updates data of the list every time a tool change is carried out.

It is the same list that appears in the tool table. See **"8.2 Tool table"** en la página 180.

Active tools

It shows the data of the active tools of each channel. It is also possible to change the tool of the spindle. See **"8.4.1 Changing the tool of the spindle"** en la página 197.

It is also shown on the tool selected on the list. This data cannot be edited on this screen. The data shown here is defined in the tool table.

8.4.1 Changing the tool of the spindle

It is possible to change the tool of the spindles from the section on active tools. The tool to be placed must be defined in the tool table.

To change the active tool, follow these steps.

1. Use the cursor to select the active tool to be modified and enter the number of the new tool.
2. Press the [CYCLE START] key to load the tool automatically or the [ENTER] key to update the positions list after a manual tool change.
3. The tool list will show that the tool is in the spindle.



TOOL AND MAGAZINE TABLE
Active-tools table

FAGOR 

CNC 8070

(SOFT V02.0x)

8.5 Table for the status of the tool change process

This screen monitors the tool changes being executed in each channel.

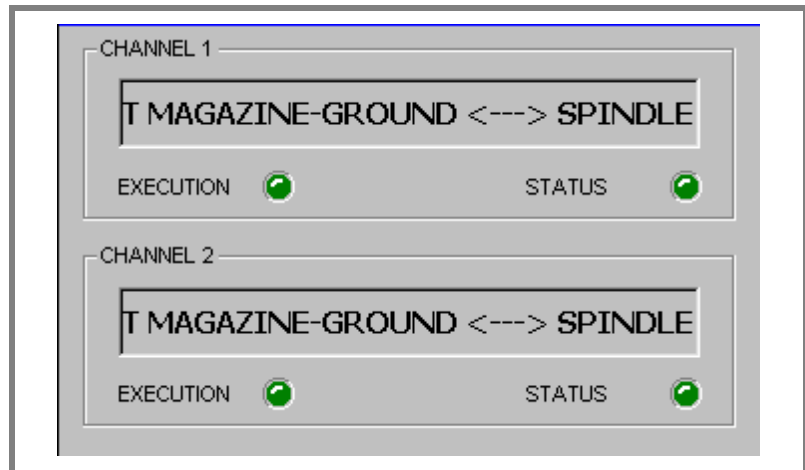

It indicates the following for each tool change process:

- The type of change selected and the magazine involved.
The type of change refers to the type of operation being carried out or to be carried out when executing function M06. The possible types of change are load a tool into the spindle or load and unload a ground tool from the magazine through the spindle.
- The "execution " LED informs that the tool change process is running and that the magazine is carrying out an operation.
- The "status" LED informs on whether the magazine is in an error state or not. To eliminate the error state, press the "Emergency reset" icon.

8.

TOOL AND MAGAZINE TABLE
Table for the status of the tool change process

8.6 Magazine table

Up to four different magazines may be configured. Each magazine has a table showing the tool distribution in the magazine and which table is in the spindle and on each holder of the changer arm (if any).

Position	Tool	Remaining life	Family
1	2	75 Min.	3
2	5	Expired	4
3	10	21 Oper.	0
4	Free		
5			
6	14	67 Min.	8
7			
8	Free		
9	Free		
10	Free		
11	Free		
12	Free		
13	Free		
14	Free		
15	Free		

INFORMATION

MAGAZINE STATUS: RESTING STATUS

TOOL CHANGER ARM: CH1: 8 MEDIUM CH2:

TOOL OF THE POSITION SELECTED ON THE LIST: ENDMILL 2 STATUS

Left pos.: 0 SMALL Right Pos.: 0 SPECIAL

MAGAZINE DATA: Geometry: LINEAR - Capacity: 20 Type: SYNCHRONOUS + 2 ARMS - NON RANDOM

(A) Magazine positions.
(B) Magazine information.

The CNC updates the table data every time a tool is changed.

Magazine positions

It shows the magazine positions and the tools in them.

Position

Magazine position. The symbol next to the number indicates the status of this position.

- Free (white filled circle).
- Half-taken (black-and-white filled circle).
- Taken (black filled circle).
- Disabled (red filled circle).

Tool

Number of the tool occupying the magazine position.

Remaining life

If the tool life monitoring is active, shows the remaining life, either in machining time or in the number of operations to be carried out or the tool status (rejected or worn out).

Family

Family the tool belongs to, defined by the user in the tool table.

8.

TOOL AND MAGAZINE TABLE
Magazine table



CNC 8070

(SOFT V02.0x)

Magazine information

The information shown is grouped as follows:

The screenshot shows the 'INFORMATION' screen with the following sections:

- (A) MAGAZINE STATUS:** RESTING, STATUS (green indicator).
- (B) TOOL CHANGER ARM:** CH1: 8 MEDIUM; CH2: (empty).
- (C) TOOL OF THE POSITION SELECTED ON THE LIST:** ENDMILL 2, STATUS (green indicator), Left pos.: 0, SMALL, Right Pos.: 0, SPECIAL (checkbox).
- (D) MAGAZINE DATA:** Geometry: LINEAR - Capacity: 20; Type: SYNCHRONOUS + 2 ARMS - NON RANDOM.

(A) Magazine status.
 (B) Tool in the spindle and in the holders of the tool changer arm.
 (C) Tool selected on the list.
 (D) Magazine data.

If the magazine is involved in a tool change at a given time, it shows the information about the status of that change; the operation is carried out when executing an M06, manager status (in execution or at rest) and the status of the change process (whether it is in error or not).

Magazine status

This area shows the operation being carried out in the magazine.

- In standby: The magazine is in standby.
- Loading: A tool is being loaded into the magazine.
- Unloading: A tool is being unloaded from the magazine.

The "Status" led informs the user whether the magazine is in an error state or not. To eliminate the error state, press the "Emergency reset" icon.

Tool changer arm

This area shows which are the tools that occupy each holder of the changer arm (number) and their sizes.

8.

TOOL AND MAGAZINE TABLE

Magazine table



CNC 8070

(SOFT V02.0x)

Selected tool

It shows the data related to the magazine of the tool selected from the list. The "status" led informs about the tool status.

Green	The tool is available.
Yellow	The tool life is about to expire.
Red	The tool is expired (worn out) or has been rejected by the PLC.

Magazine data

Description of the type of magazine.

To show and hide this information, select the "magazine data" icon.



TOOL AND MAGAZINE TABLE
Magazine table

8.6.1 Icon description (vertical softkeys)

The icons are activated with their associated softkey (F8 to F12).



The icon menu shows all the icons related to the magazine table. The group of icons of this menu may be expanded with the softkey associated with the "+" icon that offers a new set of icons.

List of icons

Force positions

It loads a tool into the spindle or on to the changer arm.

Find text

It is used to find a text or a value in the table.

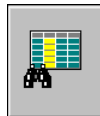

When selecting this option, the CNC shows a dialog box requesting the text to be found.

Load the tool

Selecting this icon offers two choices.

- Pressing [START]. A tool previously defined in the table is loaded into the magazine. It is loaded from ground through the spindle.
- Pressing [ENTER]. It assumes that the tool defined in the table has already been manually loaded into the magazine.

Unload the tool

Selecting this icon offers two choices.

- Pressing [START]. A tool defined in the table is unloaded from the magazine. It is unloaded to ground through the spindle.
- Pressing [ENTER]. It assumes that the tool defined in the table has already been manually loaded from the magazine.

Initialize table

(The table can only be initialized when the CNC is "READY").



Initialize (reset) the magazine table. The CNC will request confirmation of the command.

It also initializes the active-tools table because the tool arrangement in the magazine may have changed.

Save tool



It saves the table data in a file. This file may be saved at the CNC, in a floppy disk or at another CNC (or PC) connected through Ethernet.

Recall table



It recalls the table data previously saved in a file. Bear in mind that loading the tools from the magazine initializes the active-tools table.

Print table



It prints the contents of the table out to a printer connected to the CNC or as a file (*.PRN format) at the CNC.

8.

TOOL AND MAGAZINE TABLE
Magazine table



CNC 8070

(SOFT V02.0x)



Enable/disable the position

It enables or disables the magazine position selected with the cursor.

Emergency reset

It eliminates the error status of the tool manager.

Magazine data

It shows/hides the magazine data.



TOOL AND MAGAZINE TABLE
Magazine table



CNC 8070

(SOFT V02.0x)

8.7 Operations with the magazine table

8.7.1 Loading / unloading tools to / from the magazine

The tools may be loaded and unloaded to/from the magazine manually or automatically. When done manually, the positions list must be updated.

Manual load/unload

The operator places the tools directly in the magazine without using the CNC. Then, the positions list must be updated.

Automatic load/unload

The operator places the tools in the spindle and the CNC places the tool in the magazine. The positions list is updated automatically.

Initialize table



The magazine table may be reset (initialized) with the INITIALIZE icon. Initializing the table eliminates all the data about the position of the tools in the magazine.

It also initializes the active-tools table because the tool arrangement in the magazine has been changed.

Loading a tool

A tool is automatically loaded using the "Load Tool" icon. The position of the tools after a manual load may be defined with this icon or directly on the positions list.

Only the tools defined in the tool table may be loaded into the magazine and they must be defined as ground tools. In other words, they must not be in any position of the magazine, of the spindle or in the claws of the tool changer.



Even if the magazines are configured for not admitting ground tools while machining, they may be loaded into the magazine through this maneuver.

Depending on tool size, when loaded into the magazine, it may affect several positions.

8.

TOOL AND MAGAZINE TABLE
Operations with the magazine table

Magazine management using the "Load tool" icon.

1. Press the icon for "Tool loading".
2. Enter the tool number and the magazine position to insert it. If the position is not specified, it assumes the list position selected with the cursor.
3. Press the [CYCLE START] key to load the tool automatically by means of the spindle or the [ENTER] key to update the positions list.

Magazine management using the positions list.

1. Select a magazine position from the list and enter the number of the tool it occupies it.
2. Press [ENTER] to update the positions list.

Unloading a tool

A tool is automatically unloaded using the "Unload Tool" icon. The position of the tools after a manual unload may be defined with this icon or directly on the positions list.

Magazine management using the "Unload tool" icon.

1. Press the icon for "Tool unloading".
2. Enter the number of the tool to be unloaded.
3. Press the [CYCLE START] key to unload the tool automatically to the spindle or the [ENTER] key to update the positions list.

Magazine management using the positions list.

1. Select a magazine position from the list and delete the number of the tool it occupies it.
2. Press [ENTER] to update the positions list.



TOOL AND MAGAZINE TABLE
Operations with the magazine table



CNC 8070

(SOFT V02.0x)

8.7.2 Load and download a tool from the tool changer holders

To insert a tool in the holders of the changer arm (when available), it must be defined in the tool table.

To load or unload one of these tools:

1. Press the "force positions" icon.
2. Define the tool number in the positions of the tool changer arm.
When using a two-holder changer arm, there may not be tools in the spindle and in the second holder of the changer arm at the same time.
3. Press [ENTER] to update the table.

Loading tools in the holders of the tool changer arm does not allow the following operations:

- Insert in the spindle the tools that are in the holders of the tool changer arm.
- Insert the ground tools in the holders of the tool changer arm.

8.

TOOL AND MAGAZINE TABLE
Operations with the magazine table

8.7.3 Saving, loading and printing tables

Saving a table

It may be used to save the table data, in ASCII format, in a file.

Together with this table, we recommend to also save the active-tools table, if there is any. If the magazine tables are loaded later, it will initialize this table.



The data of the magazine table may be saved into a file with the SAVE icon. When pressing this icon, the CNC shows a list of files already saved

To save the table data, proceed as follows:

1. Select the folder to save them. By default, they are saved in the folder "C:\CNC8070 \MTB \DATA" or in the last folder selected by the user.
2. Define the file name at the bottom window. To replace an existing file, select it from the list.
3. Press [ENTER] to save the file or [ESC] to return to the table without saving the file.

The magazine table data is saved in a file with the extension "TPM".

Loading a table

It may be used to restore the table data, in ASCII format, from a file.

Loading the magazine table initializes the active-tools table. This is because when loading the magazine tables, the new tool arrangement may not be coherent with the active tools. This is why after loading this table, it is necessary to load the active-tools table.



The magazine table data may be recovered using the LOAD icon. When pressing this icon, the CNC shows a list of files already saved

To recover the table data, proceed as follows:

1. Select the folder containing the file. By default, they are saved in the folder "C:\CNC8070 \MTB \DATA" or in the last folder selected by the user.
2. Select the file from the list or write its name in the bottom window.
3. Press [ENTER] to recall the data from the file or [ESC] to return to the table without recalling the data.

8.

TOOL AND MAGAZINE TABLE
Operations with the magazine table

FAGOR 

CNC 8070

(SOFT V02.0x)

Print table

The magazine table data may be printed to a printer connected to the CNC or to a file (*.PRN format) at the CNC.



To print the table, use the PRINT icon. When pressing this icon, the CNC will show a dialog box requesting the print destination for the table (printer or file).

When printing to a file, it is possible to select the name and location of the file. By default in "C:\Cnc8070 \Users \Reports".

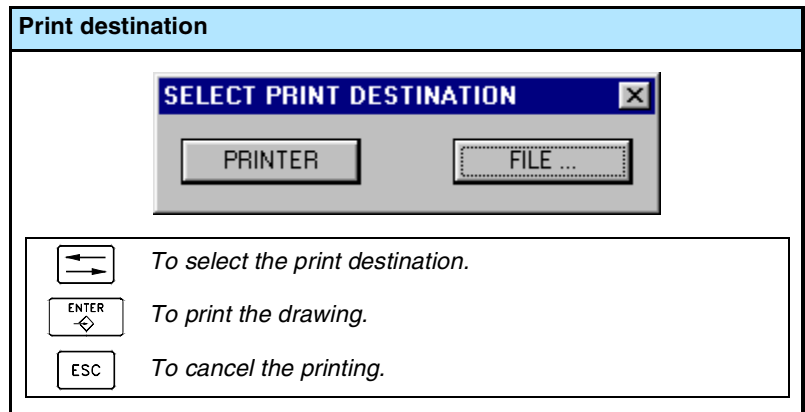

After selecting the destination, press [ENTER] to print the table or [ESC] to cancel it.

8.

TOOL AND MAGAZINE TABLE
Operations with the magazine table

8.7.4 Find text

It is used to find text or a value in the table.

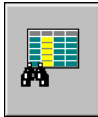

To perform the search, press the FIND icon and the CNC will show a dialog box requesting the text or value to be searched. It is also possible to select whether the search must start at the beginning of the table or at the current cursor position.

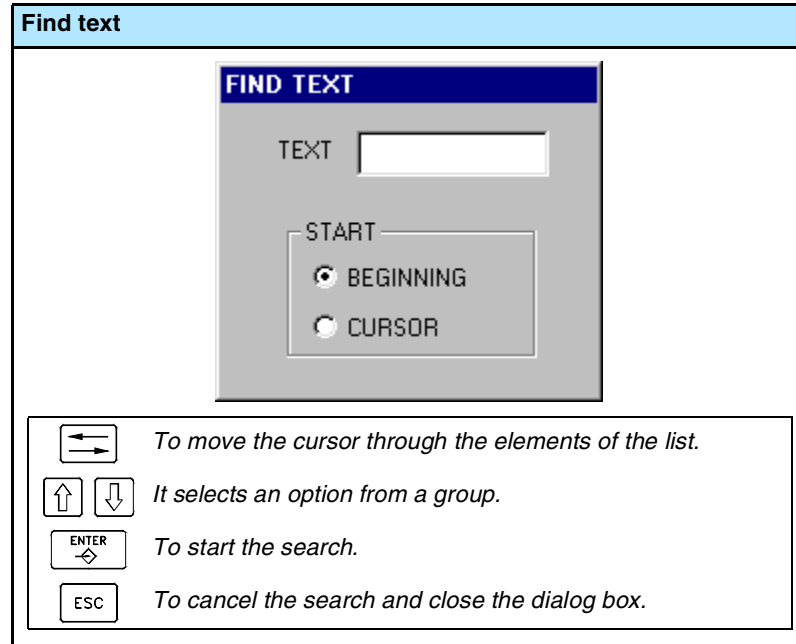

To start the search, press [ENTER] and the cursor will position on the text found. Pressing this FIND icon again will allow repeating the search or defining a new one.

8.

TOOL AND MAGAZINE TABLE
Operations with the magazine table

8.

TOOL AND MAGAZINE TABLE

Operations with the magazine table



CNC 8070

(SOFT V02.0x)

▼ Utilities mode selection



The utilities mode may be accessed from any other operating mode, even while a program is in execution, by pressing the relevant key.

▼ Operations in this work mode

This work mode shows the files that may be accessed from the CNC and may be used for the following operations:

- See the files stored at the CNC, in a floppy disk or at another CNC (or PC) connected via Ethernet.
- Create new folders to save files.
- Select a file group and carry out operations such as copy, rename or delete files.
- Change file attributes.
- Do a file search based on a text already defined in them.
- Set a password to restrict the access to the customizing tool FGUIM, to machine parameters and to the PLC.
- Make or restore a backup copy of the CNC data.

9.1 Appearance of the utilities mode

When this operating mode is active, it will be indicated at the top right side of the general status bar. This mode only has one screen.

Standard configuration

The standard configuration of this work mode, described in this manual corresponds to the one supplied by Fagor. In some cases, the manual shows a sample screen, instead of that of the CNC in order to make it easier to understand.

9.

UTILITIES MODE

Appearance of the utilities mode



CNC 8070

(SOFT V02.0x)

9.1.1 Screen description

The utilities mode screen shows the following information:

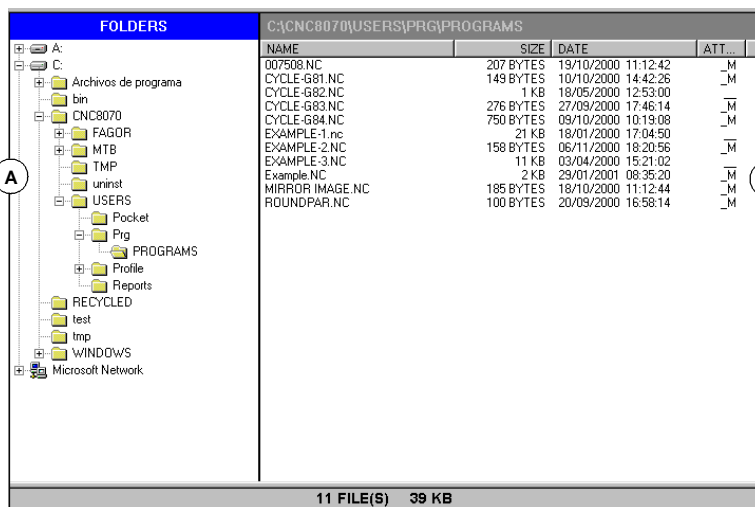

A. Folder tree.

It may show the folders of the CNC, of a floppy disk or another CNC (or PC) connected via Ethernet.

B. List of files saved in the selected folder.

To switch windows, press the relevant key.



Softkey menu

When selecting the utilities mode, the horizontal softkey menu will show the options related to this work mode.

9.
UTILITIES MODE
Appearance of the utilities mode

9.1.2 Window description

Folder tree

This window shows the folders that may be accessed from the CNC, as well their structure. Besides the CNC folders, it may show those of a floppy disk or another CNC (or PC) connected via Ethernet.

The folders may contain files and other folders.

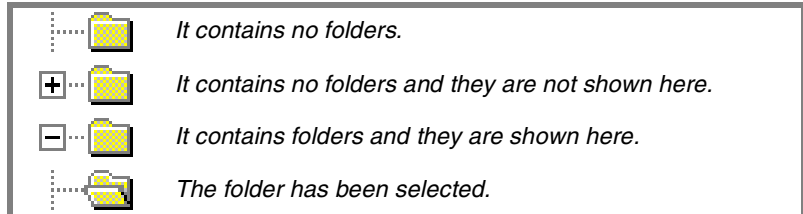

To select a folder from the list:

- Move the cursor with the relevant keys.
- Using the alphanumeric keyboard, pressing a key will select the first element starting with that letter. Pressing it again will select the second one and so on.

Keys to select a folder	
	<i>To switch windows (folders or files).</i>
	<i>To close and open a folder submenu.</i>
	<i>To move the cursor thru the elements of the window.</i>
	<i>To move the cursor page by page.</i>
	<i>To move the cursor to the beginning or end of the list.</i>

When selecting a folder, the CNC shows a list of the files it contains (See the "9.2.2 Options" section of this chapter). Likewise, the bottom of the window will show the number of files contained in the folder and the total size (bytes) they amount to.

List of files

This window shows the files stored in the selected folder. Any of them may be deleted, renamed, its protections changed and copied within the same device (CNC, PC, floppy disk) or between two different devices.

This window offers the following information:

- The file name.
- The file size, in bytes.
- The time and date when the file was edited last.
- The attributes of the file.

9.

UTILITIES MODE
Appearance of the utilities mode

Attributes. Modifiable and hidden files

Only the letters of the attributes currently selected will be shown. Those not selected will appear as "_" .

H The file is hidden and it will not appear when selecting a program for editing or execution.





Remember that a hidden file can still be deleted if its name is known. To prevent that (if so wished) its "modifiable" attribute should be removed.

M The file may be modified; in other words, edited, copied, deleted, etc.

Select files from the list

To copy, rename, delete, etc. the files must be previously selected on the list. A file may be selected from the list:

- Move the cursor with the relevant keys.
- Using the alphanumeric keyboard, pressing a key will select the first element starting with that letter. Pressing it again will select the second one and so on.
- Using the "file search" option of the softkey menu permits looking for all the files that contain the indicated text.

Keys for selecting a file	
	To switch windows (folders or files).
	To move the cursor thru the elements of the window.
	To move the cursor page by page.
	To move the cursor to the beginning or end of the list.

To select a group of files, keep the [SHIFT] key pressed while the moving the cursor. To add or remove a file from the selection, keep the [CTRL] key pressed and place the cursor on the file and press [SPACE] key.

9.1.3 Vertical softkey menu (icons)



The icon menu always shows all the icons related to the Utilities mode. The group of icons of this menu may be expanded with the softkey associated with the "+" icon that offers a new set of icons.

List of icons



Cut

Copies the selected files on the clipboard. After pasting the content of the clipboard, the files are deleted from the folder.

(This icon is only available when there is a file selected).

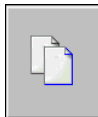

Copy

Copies the selected files on the clipboard.

(This icon is only available when there is a file selected).

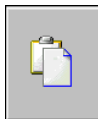

Paste

Pastes the files from the clipboard into the selected folder. If the files were placed using the "Cut" option, they will be removed from their original location.

The contents of the clipboard are not eliminated after "pasting". Therefore, this pasting operation may be repeated as often as you wish.

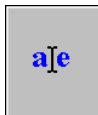

Rename

It is used to change the name of the folder or file currently selected.

- When renaming a folder, if there is one already with the new name, the proposed name change will be ignored and the folder will keep its original name.
- If when renaming a file, there is a previous file with the same name in the folder, the new file replaces the previous one.

9.

UTILITIES MODE
Appearance of the utilities mode



Modifiable file

It is used to change the "modifiable" attribute of the selected files. This attribute allows protecting the files so they cannot be modified in the editing mode.

The attributes column shows the letter -M- indicating that the program may be modified.

When a program is NOT modifiable, its contents may be viewed; but cannot be modified.



Hidden file

It is used to changed the "hidden" attribute of the selected files. This attribute allows protecting the files so they are not displayed when selecting a program to be edited or executed.

The attributes column shows the letter -H- indicating that the program will be hidden (not visible).

However, a hidden program may be deleted if its number is known; therefore, it is recommended to remove the modifiable attribute (M) in order to avoid deleting it.

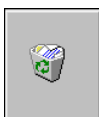

Remove file

It is used for deleting the selected folder or files.

To delete the files, the CNC will show a dialog box requesting confirmation of the command whereas the empty folders will be deleted directly without requesting confirmation.

The folders can only be deleted if they are empty.



UTILITIES MODE

Appearance of the utilities mode



CNC 8070

(SOFT V02.0x)

9.2 Utilities (Softkeys)

9.2.1 Sorted by

It is used to order the list of files.



When selecting this option, the softkey menu shows the different ordering options. To return to the previous menu, press the key for the previous menu.

The file list may be ordered alphabetically, by size, by data or by type. When pressing the same ordering criteria twice, the CNC toggles from ascending to descending and vice versa.

The softkey menu shows the ordering criteria currently selected (the softkey will appear pressed).

9.2.2 Options

It is used to personalize how the program listing will be displayed on the screen.



When selecting this option, the softkey menu shows the following personalizing options. To return to the previous menu, press the key for the previous menu.

Update

It updates the list of files showing the files of the folder currently selected. Only when the "auto-update" option is not active.

Auto-update

When this option is selected (the softkey will appear pressed), every time a folder is selected, the CNC will automatically update the list of files.

Column adjust

When this option is selected (the softkey will appear pressed), the columns of the file lists will adjust to the text they contain so as to show the text that may be truncated because it is too long.

Reset all

It closes the folder tree (layout) and it only shows the devices (floppy disk, Ethernet network, etc.) connected to the CNC.

Show hidden files

When this option is selected (the softkey will appear pressed), the file list shows all the files of the selected folder even those having the "hidden" attributes. Otherwise, these files will not be shown.

9.

UTILITIES MODE
Utilities (Softkeys)

9.2.3 Search in files

It is used to search files. When selecting this option, the CNC shows a dialog box where the following data may be defined:

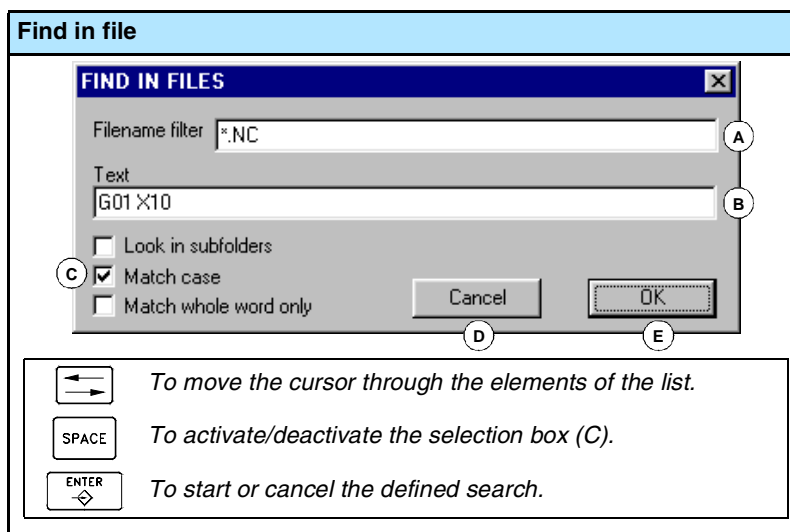

A. Description of the files to be searched. The "*" and "?" wild characters may be used on the search, meaning:

- * Any character string.
- ? Any character.

In such a way that:

- * Looks for all the files.
- *.NC Looks for all the files having the extension "NC".
- exa*.* Looks for all the files beginning with "exa".

B. Text included within the files.

C. Defines the search criteria.

- Look in the sub-folders.
- Ignore uppercase and lowercase.
- Consider the text to find as a whole word.

D. Start the defined search.

E. Cancel the defined search.

After defining the search options, place the cursor on one of the lower buttons to accept (D) or cancel (E) the defined search and press [ENTER].

The file window will show the list of the programs found.







9.

UTILITIES MODE
Utilities (Softkeys)

9.2.4 Select all

It selects all the files of the list. The selection will be canceled by moving the cursor.

To add or remove a file from the selection, keep the [CTRL] key pressed and place the cursor on the file and press [SPACE] key.







Keys to move the cursor	
 	Moves the cursor line by line.
 	To move the cursor page by page.
 	Moves the cursor to the first block or to the end of the window.

Having selected a group of files, they may be deleted, copied, cut or their attributes may be changed by pressing the relevant icon.

9.2.5 Invert selection

It inverts the file selection made selecting the files that appeared unselected and vice versa.

To add or remove a file from the selection, keep the [CTRL] key pressed and place the cursor on the file and press [SPACE] key.



Keys to move the cursor	
 	Moves the cursor line by line.
 	To move the cursor page by page.
 	Moves the cursor to the first block or to the end of the window.

Having selected a group of files, they may be deleted, copied, cut or their attributes may be changed by pressing the relevant icon.

9.2.6 New folder

It is used to create a new folder to store files.

When selecting this option, the CNC shows a dialog box requesting the file name. Write the new name and select one of the buttons to accept it or ignore it.

	To move the cursor through the elements of the list.
	To confirm the option selected with the cursor.

If when defining the folder name, there is already a folder with the same name, it will NOT create the new folder.

9.

UTILITIES MODE
Utilities (Softkeys)

FAGOR 

CNC 8070

(SOFT V02.0x)

9.2.7 Protection passwords

The passwords may be used to define each of the codes that the user will have to enter in order to access certain CNC functions. If entered correctly, it stores it and it does not request it again unless the CNC is turned off. If the password is wrong, the requested action cannot be carried out and it requests it again every time.

Press the "Passwords" softkey to access the password setting screen. The following passwords may be defined.

- General password.
- PLC.
- Machine parameters.
- Customizing.
- Machine parameters for kinetics.

General password

It is requested when trying to access this password setting screen.

PLC

It is requested when trying to carry out the following actions at the PLC:

- Editing the PLC program. When entering the wrong password, the PLC program opens as read-only.
- Adding a file to the project.
- Deleting a file.
- Renaming a file.
- Editing PLC messages. When entering the wrong password, the PLC messages may be neither displayed nor edited.
- Generate PLC.
- When accessing to the "Commands" service options.
- In monitoring, when modifying the status of a resource.

Machine parameters

It is requested when trying to carry out the following actions in the machine parameter table:

- Modifying the value of a parameter.
- Initialize a table.
- Loading a table.

Customizing

It is requested when entering the FGUIM application. When entering the wrong password, it will not be possible to access the application.

9.

UTILITIES MODE
Utilities (Softkeys)

FAGOR 

CNC 8070

(SOFT V02.0x)

Machine parameters for kinetics

It is requested when trying to carry out the following actions in the machine parameter tables for the kinematics: If not set, it will apply the password used in the rest of the machine parameters.

- Modifying the value of a parameter.
- Initialize a table.
- Loading a table.





9.

UTILITIES MODE
Utilities (Softkeys)

How to set the protection passwords

Press the "Passwords" softkey to access the password setting screen. From this screen, it is possible to define, modify or delete the passwords. If this screen is protected, pressing the softkey will request the general password.

Each password may be up to 10 ASCII characters long. It is case sensitive.

Keys to set the password	
	To select the previous or next password.
	It assumes the defined password.
	To cancel the defined password.
	It deletes the selected password.

The "Delete all" softkey deletes all the passwords defined.

9.2.8 Data safety backup. Backup - Restore

This option may be used to make a backup copy of the data of the MTB folder in order to be able to restore this configuration later on if necessary. The backup is saved in a single file.

Both the folder being backed up and the file name it is saved in may be configured. When not indicated otherwise, it makes a backup of the "MTB" folder and it saves it in the *mtb.r* file in unit –A:–.

Configuring backup options

The backup options may be defined using the "Backup options" softkey. As backup options, it is possible to define both the folder being backed up and the name of the file containing the data. By default, it makes a backup of the "MTB" folder and it saves it in the *mtb.r* file in unit –A:–.

The CNC saves the defined options in a file called *backup.ini*. If this file does not exist when making or restoring a backup, the default values will be used.

Making a data backup

The backup is made using the "automatic backup" softkey. Pressing this softkey makes a safety copy of the data of the indicated folder. The data is saved in the selected file.

When not indicated otherwise or if the *backup.ini* file does not exist, it will make a backup of the "MTB" folder and will save it in the *mtb.r* file in unit –A:–

Restoring data from a backup file

Backup data is restored using the "Restore backup" softkey. Pressing this key copies the data from the indicated file to its original folder; i. e. To the folder that was backed up. If this folder does not exist, it creates it and goes on with the operation.

If the files being restored already exist, they will be overwritten; i.e. the ones in the folder will be replaced by the ones in the backup.

The name of the file from which the backup is restored is defined in the *backup.ini* file. If this file does not exist, it proceeds as follows:

1. It looks for the *mtb.r* file in unit –A:– and it restores it.
2. If this file does not exist, it restores the first backup file (extension –r–) of unit –A:–
3. If there is no backup file, it shows the relevant error message.

9.

UTILITIES MODE
Utilities (Softkeys)

FAGOR 

CNC 8070

(SOFT V02.0x)

9.

UTILITIES MODE Utilities (Softkeys)



CNC 8070

(SOFT V02.0x)

In this operating mode, the PLC may be accessed to check its operation or the status of the different PLC variables. It is also possible to edit and analyze the PLC program as well as the message and error files of the PLC.

MDI mode selection



The PLC mode may be accessed either using the user key customized for it or from the tasks window. The task window may be accessed with key combination [CTRL]+[A].

What can you do in this work mode?

In short, the PLC mode offers the following operations:

- Edit, modify or view the contents of the PLC project.
- Debug the PLC program by executing the different parts of the program separately (first cycle, main module, periodic module).
- Analyze the behavior of the logic signals of the PLC program depending on a time base and triggering conditions set by the user.
- Monitor the status of PLC resources and variables.
- See all the resources used in the PLC project and in which program of the project they are being used.
- Run statistics on execution times of the PLC project and of the modules that form it.
- Edit, modify or view the texts associated with the messages and errors of the PLC.

10.1 Appearance of the PLC mode

When this operating mode is active, it will be indicated at the top right side of the general status bar.

This operating mode may be displayed with several screens. Each of them corresponds to a PLC service. The exchange between the different services is carried out with the list of services.



The different services overlap each other. If several services active, it is possible to switch from one to another using the relevant key, if it has been set accordingly. The services are switching in a rotary manner, in such a way that when pressing on the last active service, it shows the first one.

Standard configuration

The standard configuration of this work mode, described in this manual corresponds to the one supplied by Fagor. In some cases, the manual shows a sample screen, instead of that of the CNC in order to make it easier to understand.

10.

PLC

Appearance of the PLC mode

10.1.1 Screen description

The PLC mode screen shows the following information.

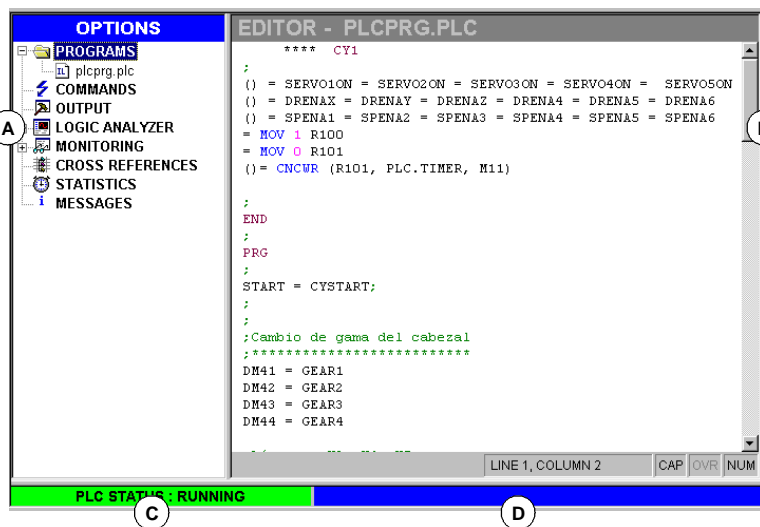

A. Service window.

It shows a list of the services available in the PLC environment.

B. Data window.



It shows the screen associated with the selected service, if any. The screens of the different services overlap each other. If several services active, it is possible to switch from one to another using the change key, if it has been set accordingly. To close a screen, press [ESC].

C. It shows the PLC status, running or stopped.

D. CNC messages.



To switch windows, press the relevant key.

Keys for selecting a service	
	To close and open the file list of a service.
	To move the cursor thru the services of the window.
	To move the cursor to the beginning or end of the list.
	To acces the service selected with the cursor.

Softkey menu

When selecting the PLC mode, the horizontal softkey menu will show the options associated with the PLC service currently selected. The set of options offered by this menu may be changed using the "+" softkey which offers a new set of options.

10.

PLC
Appearance of the PLC mode

10.1.2 Icon description (vertical softkeys)

The icon menu always shows all the icons associated with the active PLC service.

The icons are activated with their associated softkey (F8 to F12).

List of icons

10.

PLC

Appearance of the PLC mode

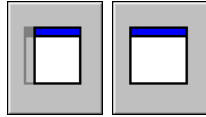

Show/hide the service window

It toggles between the shared usage of the area of the PLC environment (that displays both the service window and the data window) and the full work screen (hiding the service window so the data window is expanded covering the whole area of the PLC environment).

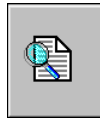

Find text

It is used for searching a text in all the files of the project. The result will be shown at the "Outputs" service.



Go to file

(It only appears when working with the "Outputs" or "Cross references" service).

If the cursor is positioned on the result of a text search, a compiling error or a PLC resource, after selecting this option, it opens the corresponding file and the cursor goes to the line it refers to.

10.2 "Programs" service

This service is used for managing the PLC project and its files. The PLC project may consist of several files edited in any of the following languages:

- Equations or mnemonics (extension *.PLC).
- C language (extension *.C).

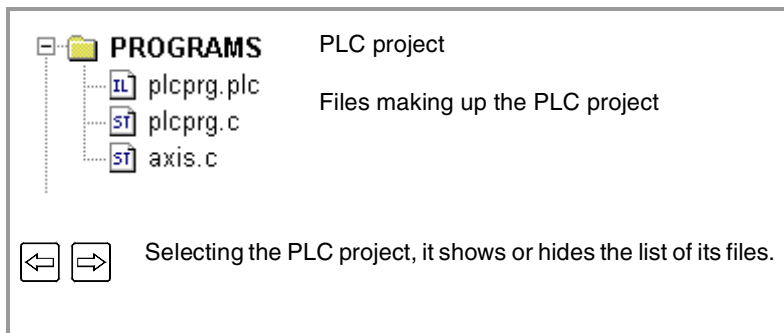

10.
PLC
"Programs" service

PLC project

The PLC project is a set of files that, once compiled, generate the PLC program.

When selecting the PLC project, the softkey menu will show the options to manage that project. Among these options, it is possible to add files to the PLC project and compile it.

Files of the PLC project

As mentioned earlier, the PLC project may consist of one or several files edited in one of the following languages:

- Equations or mnemonics.
- C language.

One of the files of the PLC project may be edited in mnemonic languages (extension *.PLC). The rest must be edited in "C" language (extension *.C).







When selecting a file, the softkey menu shows the options to manage that file. Among these options, it is possible to edit and monitor the file. These options will show the editing and monitoring screens.

10.2.1 PLC project (softkeys)

These options are used to create a PLC project and compile it to create the executable PLC program.

PLC project "Add file"

It is used to add a file to the PLC project. This file may be a new one or an existing one. When selecting this option, the CNC shows a list of the available files.

		To switch windows.
		To move the cursor through the elements of the list.
		To add the selected file.
		To cancel the selection and close the program listing.

To add a file to the PLC project.

1. Select the file from the list or write its name in the bottom window.
2. Press [ENTER] to accept the selection and add the file or [ESC] to cancel the selection and close the file listing.

When accepting the selection, the selected file will appear on the list that make up the PLC project.

PLC project "Generate PLC"

It compiles and loads the PLC program based on the files that make up the PLC project. If an error occurs during compilation, the program will not be generated and the CNC will display a list of the detected errors.

10.

PLC
"Programs" service

10.2.2 Files of the PLC project PLC (Softkey)

When selecting a program of the PLC project at the service window, the softkey menu will offers the following options.

Files of the PLC project "Edit"

It is used to edit the selected PLC file.

Selecting this option access the editing window (section on **"10.3 Program editing"** in this chapter).

Files of the PLC project "Monitoring"

It is used to monitor the selected PLC file.

Selecting this option access the monitoring window (section on **"10.5 Program monitoring"** in this chapter).

Files of the PLC project "Eliminate"

It deletes the selected file of the PLC project (the file will still be available in the CNC's hard disk).





Files of the PLC project "Rename"

It is used to change the name of the selected file.

Files of the PLC project "Copy"

It is used to make a copy of the selected file.

When selecting this option, the CNC shows a list with the programs stored at the CNC.

	To switch windows.
	To close and open a folder submenu.
	To move the cursor thru the elements of the window.
	To save the new program.
	To cancel the selection and close the programs listing.

To make a copy of the file:

1. Select the destination folder for the copy.
2. Define the file name at the bottom window. To replace an existing file, select it from the list.
3. Press [ENTER] to copy the file or [ESC] to cancel the selection and close the file listing.

10.

PLC
"Programs" service

FAGOR 

CNC 8070

(SOFT V02.0x)

10.3 Program editing

To edit a program, select it at the service window and select the "Edit" option of the softkey menu. The CNC will access the program editor and will show the contents of the selected program.

To close the edit window, press [ESC].

Editor description

The editing window shows the following information:

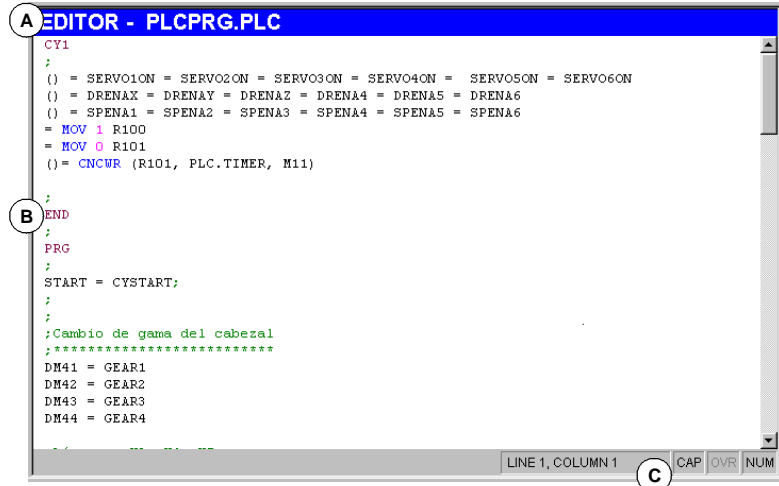

A. Title bar.

Name of the program selected for editing. An "*" next to the program name means that the changes made to the program have not been saved (the program must be saved so they do not get lost).

B. Edit area.

Program editing area showing its contents.

C. Status bar.

Information about cursor position and the status of the editor options such as:

- CAP** Capital letters. When active, the text is always written in capital letters.
- OVR** Overwrite text. It toggles between overwriting and inserting text. When active, it overwrites the existing text.
- NUM** Numeric keypad active.

Softkey menu

When accessing the PLC program editor, the horizontal softkey menu will show all the options associated with editing a file.

10.

PLC
Program editing



CNC 8070

(SOFT V02.0x)

10.4 Program editing (softkeys)

10.4.1 Analyze

It analyzes the program searching for errors. The errors found will be displayed in the "Outputs" service window.



To close this window and return to the editor, press [ESC]. To return to the editor without closing the window, press the screen switching key.

10.4.2 File



It is used to restore, save, import or print a file.

When selecting this option, the softkey menu shows the available options. To return to the main menu, press the key for the previous menu.

File "Restore original"

This option will only be available when the "auto-save" option is active (the section on "[10.4.6 Customizing](#)" in this chapter).

It is used to recover the original file without the changes made since the last time it was opened. When selecting this option, the CNC requests confirmation of the command.

File "Save"

This option will only be available when the "manual-save" option is active (the section on "[10.4.6 Customizing](#)" in this chapter).

It is used for saving the file that is being edited.

File "Save as"

It is used to save the file, that is being edited, with a different name. After saving the file, one keeps editing the new file.

File "Include program"

It is used to import the contents of a file saved at the CNC into the program that is being edited.

File "Print"

It is used to print the file, that is being edited, out to a printer connected to the CNC.

10.

PLC
Program editing (softkeys)

10.4.3 Undo

To "undo" the last modifications made. The modifications are undone one by one starting from the most recent one.

10.4.4 Operations with blocks

10.

PLC
Program editing (softkeys)

It is used to copy, cut and paste the information of a block or set of blocks and export this information as an independent program.

This option is only available when there is a text selected in the program or on the clipboard. To select a text in the program, keep the [SHIFT] key pressed while moving the cursor.



When selecting this option, the softkey menu shows the available options. To return to the main menu, press the key for the previous menu.

Operations with blocks "Copy"

It copies the selected text onto the clipboard.

Operations with blocks "Cut"

Copies the selected text onto the clipboard and deletes it from the program.

Operations with blocks "Paste"

Pastes the contents of the clipboard into the program.

Operations with blocks "Copy to program"

Saves the selected texts as an independent program.

When selecting this option, the CNC shows a list of the available programs. To save the text as a program:

1. Select the destination folder.
2. Define the file name at the bottom window. To replace an existing file, select it from the list.
3. Press [ENTER] to save the program or [ESC] to cancel the selection and close the program listing.

10.4.5 Find/Replace

It is used for searching for a line or a text in a program. It can also replace a text with another text.

When selecting this option, the CNC shows a dialog box requesting the line number or the text to look for. When defining a text search, certain options may also be defining that allow:

- A. Replacing the text being searched with another in the program.
- B. Ignore uppercase and lowercase.
- C. Consider the text to find as a whole word.
- D. Select whether the search starts at the beginning of the program or at the cursor position.

Find/replace

FIND / REPLACE

GO TO LINE

FIND TEXT

REPLACE WITH

A MATCH CASE

B MATCH WHOLE WORD ONLY



C

START

BEGINNING

CURSOR

D

	To move the cursor through the elements of the list.
<input type="text" value="SPACE"/>	To activate/deactivate the selection box (B) (C).
	To select an option of a group (D).
<input type="text" value="ENTER"/>	To start the search.
<input type="text" value="ESC"/>	To cancel the search and close the dialog box.

After defining the search options, press [ENTER] to start the search or [ESC] to cancel it.

The text found in the program will be highlighted and the softkey menu will show the following options:

- Replace, to replace the highlighted text.
- Replace all, to replace the text throughout the whole program.
- Find next, to skip this text and keep on searching.

To end the search, press [ESC].

10.

PLC
Program editing (softkeys)

10.4.6 Customizing

It is used for personalizing the appearance and properties of the editing window.



When selecting this option, the softkey menu shows the available options. To return to the main menu, press the key for the previous menu.

Customizing "Appearance" (looks)

It is used for personalizing the look of the different elements of the editing window and the colors of the elements of the program.

When selecting this option, the CNC shows the dialog box with two panels. The first one has the elements of the editing window that may be customized and the second one those of the program. The panel is selected by the key combination [CTRL]+[TAB].

10.

PLC
Program editing (softkeys)

Set aspect

GENERAL OPTIONS | **SINTAX COLORING**

EDITOR (A)

ERROR WINDOW

TITLE

STATUS BAR

TEACH-IN

FONT

Courier New (B)

13 SIZE

ITALIC (C)

BOLD (C)

TEXT

 (B)

BACK

TEXT

To move the cursor through the elements of the list.

To select an option of a group (A).

To turn on/off the checkboxes (C), and to open/close the drop lists (B).

After defining the new look, use the cursor to select one of the buttons here below to accept or ignore the changes made and press [ENTER].

Aceptar (A)

Cancelar (B)

Aplicar (C)

(A) To accept the changes and close the dialog box.
 (B) To ignore the changes and close the dialog box.
 (C) To apply the changes and close the dialog box.

The dialog box may also be closed directly without accepting the changes by pressing [ESC].



CNC 8070

(SOFT V02.0x)

Customizing "Save always" & "Not always"

It is used to save the program automatically or manually.

- When "auto-save" is on, the CNC will automatically save the program after every change.
- When "manual save" is active, the user must save the program (as explained in the "[10.4.2 File](#)" section of this chapter).

10.

PLC
Program editing (softkeys)

FAGOR 

CNC 8070

(SOFT V02.0x)

10.5 Program monitoring

To monitor a program, select it from the list of the service window and select the "Monitoring" option of the softkey menu. The CNC will display the monitoring window and it will show the instructions of the selected program.

To close the monitoring window, press [ESC].

Description of the monitoring window

The editing window shows the following information:

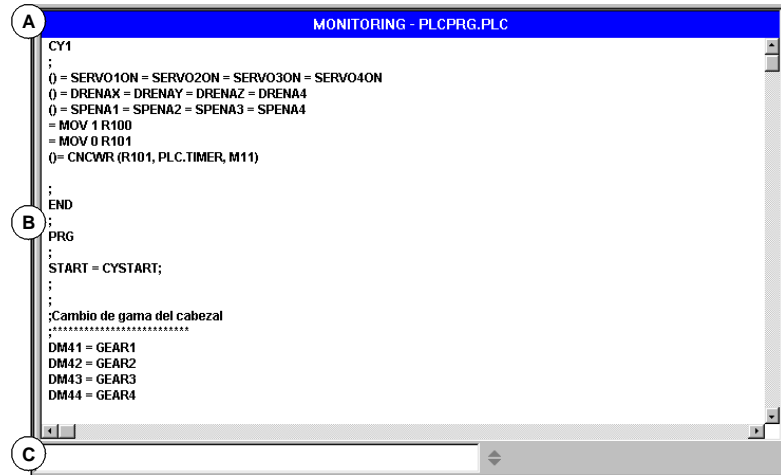

A. Title bar.

It shows the name of the program that is being monitored.

B. Monitoring area.

It shows the status of the instructions being executed. It is a real-time monitoring. Only the instructions that are being executed are monitored.

The PLC will show, in a different color, the instructions that are not being executed such as the first cycle or those subroutines whose call is not active. The default colors are:

- Red Active variables.
- Green Instruction that is not being executed.
- Black Inactive variable or comment.

C. Data entry area.

It is used to modify the values of the PLC resources.

10.

PLC
Program monitoring

10.6 Program monitoring (softkeys)

When selecting the "Monitoring" option of the softkey menu, the following options will appear.

Monitoring "Size +"

Every time this softkey is pressed, the size of the text will increase.

Monitoring "Size -"

Every time this softkey is pressed, the size of the text will decrease.

Monitoring "Bold"

When selecting this option, the text of the program appears in bold.

Monitoring "OFF/ON"

It interrupts and resumes program monitoring. While monitoring is interrupted, the resource status changes are not updated.

Interrupting the monitoring does not stop the execution of the PLC.

Monitoring "Find"

To find text in a program.

When selecting this option, the CNC shows a dialog box requesting the text to be found. Key in the text and press [ENTER] to begin the search.

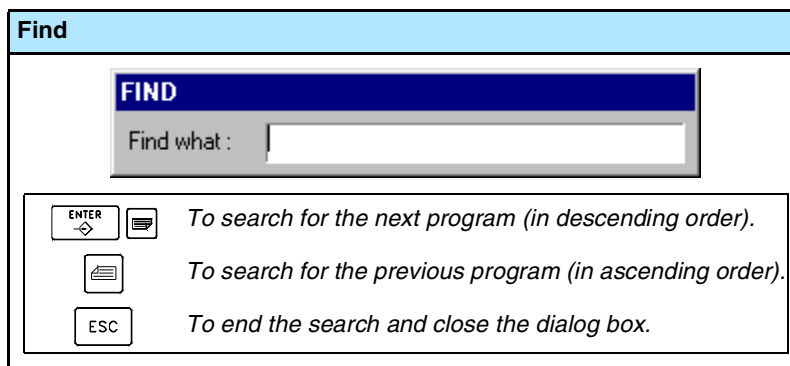

As the text is being searched, the cursor will position on the match found. To end the search, press [ESC].

Monitoring "Customize"

It is used to personalize certain functions of the monitoring window. When selecting this option, the CNC shows a dialog box with the options available for customizing.

10.7 "Commands" service

The "Commands" service is used to debug the PLC program execution by taking advantage of the possibility to execute the various parts of the program separately (first cycle, main module and periodic module). This service also offers the possibility of starting up and interrupting the execution of the PLC program.

When selecting this service, the horizontal softkey menu offers all the options associated with this service.

10.

PLC
"Commands" service

10.7.1 Options of the "Commands" service (softkeys)

Commands "Run"

It starts the execution of the PLC program.

1. The first cycle (CY1) is executed once.
2. Cyclic execution of the main program (PRG) and the periodic module (PE).

The main program is executed according to the frequency defined by machine parameter.

The periodic module is executed according to the frequency defined in the program.

Commands "Stop"

It interrupts the execution of the PLC program.

Commands "CY1"

It executes the part of the program corresponding to the first cycle (CY1). The CNC does not execute this option when the PLC program is running.

Commands "Cycle"

It executes the main program (PRG) once. The CNC does not execute this option when the PLC program is running.

Commands "Resume"

It resumes the cyclic execution of the PLC program. The CNC does not execute this option when the PLC program is running.

Commands "PE module"

It executes the periodic module (PE) once. The CNC does not execute this option when the PLC program is running.

10.8 "Outputs" service

The "Outputs" service shows the following information:

- The result of generating (compiling) the PLC program.
- The result of analyzing a file of mnemonics.
- The result of text search in the files making up the PLC project.

Pressing the "Show" softkey accesses the screen of this service that shows this information. To close the window, press [ESC].

10.

PLC
"Outputs" service

Description of the outputs service

The screen of this service looks like this:

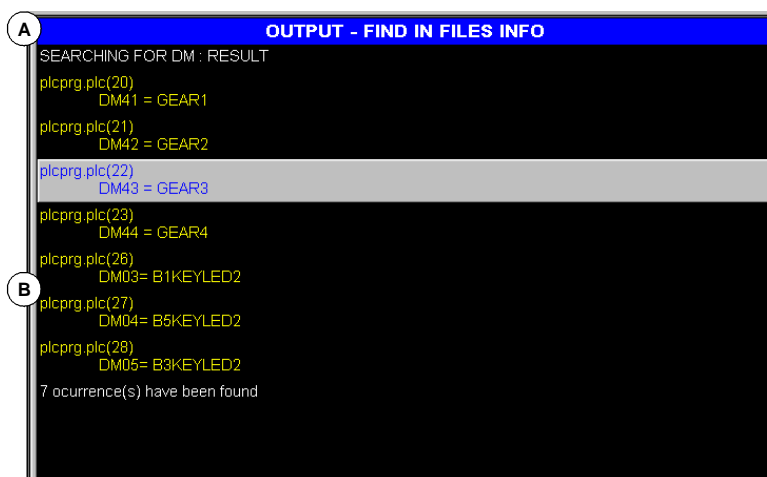

A. Title bar.

It shows the type of information displayed in the window (information about the compilation, file analysis or a search).

B. Requested information.

It shows the requested information.

10.8.1 Options of the "Outputs" service

When accessing the "Outputs" service, the softkeys will show the following option.

Outputs "Compiling info"

It shows the result of compiling (generating) the PLC program. The screen shows a list of warning or errors detected when compiling the PLC program.



After selecting a warning or error from the list, it is possible to go to the erroneous line by pressing the relevant icon.

Keys to move the cursor		
		To select the previous or next message or error.
		To select the previous or next information page.
		To select the first or last message or error from the list.

Outputs "Checking info"

It shows the result of analyzing the file of mnemonics. The screen shows a list of the error detected when analyzing the program.

After selecting a warning or error from the list, it is possible to go to the erroneous line by pressing the relevant icon.

Outputs "Search info"

It shows the result of searching text in the programs making up the PLC project.

After selecting an element from the list, it is possible to go to its line by pressing the relevant icon.

10.9 "Logic analyzer" service

The "Logic analyzer" service is used to analyze the behavior of the logic PLC signals according to a time base and certain trigger conditions set by the user.

Up to 8 PLC variables or expressions may be analyzed at the same time and the result of the analysis (the traces) will appear on a graphic interface that facilitates the interpretation of the data. Once the done capturing data, the user may:

- Modify the time base to display different zooms of the traces.
- Move along the traces to display points, times, time differences, etc.

To close the window, press [ESC].

Description of the logic analyzer

The logic analyzer looks like this:

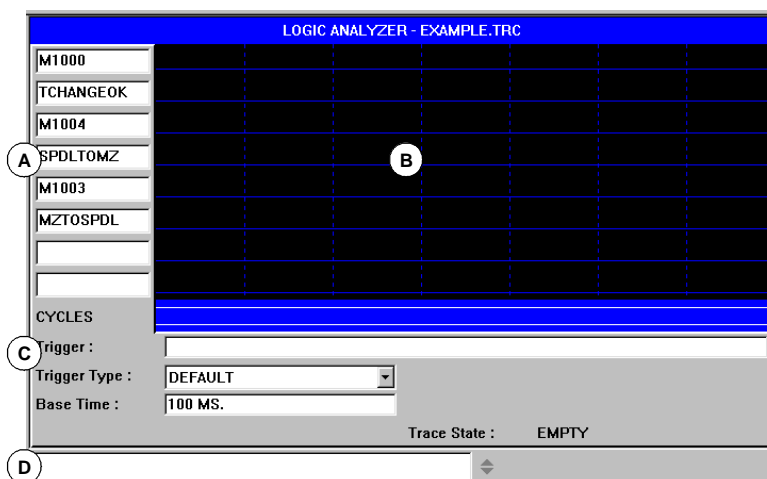

- A.** The data area is used to define the variables or expressions to be analyzed. Up to 8 PLC variables or expressions may be defined.
- B.** The graphic area shows the traces for the defined PLC variables or expressions and a trace of the PLC cycles with the indicated conditions.
Also, a vertical red line is displayed to indicate the trigger point (if any) and a green line to indicate the cursor position.
- C.** The information area is used to define the data that conditions the display of the traces (trigger, type of trigger, time base and trace status).
- D.** The data entry area is used to modify the PLC resources.

10.

PLC
"Logic analyzer" service

Softkey menus

When selecting the logic analyzer, the horizontal softkey menu offers all the options associated with this service. The set of options offered by this menu may be changed using the "+" softkey which offers a new set of options.

10.

PLC

"Logic analyzer" service







CNC 8070

(SOFT V02.0x)

10.9.1 Editing logic analyzer data

In order to capture trace data, the user must enter the variables or expressions to be analyzed, the trigger type and conditions as well as the time based to be used to display the captured values.

To edit this data, select the graphic area of the logic analyzer and press the "Edit view" softkey to place the cursor on the data editing area.

Keys for defining the data of the logic analyzer	
	To move the cursor through the data.
	To move the cursor within a data.
	To display the drop list menus.
	To validate the defined data.
	To quit (cancels) editing data.

Definition of variables

Up to 8 PLC variables or expressions may be defined to obtain their trace. The definition of the expression cannot exceed 80 characters.

When modifying a variable, if there was already a trace of that expression, the trace will be deleted when validating the new edition.

Trigger condition

A trigger condition is the one used to capture data and may be defined with a PLC variable or expression. The definition of the expression cannot exceed 80 characters.

If the trigger condition is modified after a data capture, all the traces will be deleted when validating the new condition.

Trigger type

It sets whether the data is to be captured "before", "after" or "before and after" the selected trigger condition is met.

By default	The data capture starts and ends when the operator selects the option to execute and stop the trace.
Before	The data capture starts when the trigger condition is met and ends when the operator selects the option to stop the trace. Once the trace has been executed, the trigger signal will be shown at the beginning of the trace.
After	The data capture starts when the operator selects the option to execute the trace and ends when the trigger condition is met. Once the trace has been executed, the trigger signal will appear at the end of the trace.
In the middle	The data capture starts and ends when the operator selects the option to execute and stop the trace. Once the trace has been executed, the trigger signal will be shown at the center of the trace.

10.

PLC
"Logic analyzer" service

FAGOR 

CNC 8070

(SOFT V02.0x)

10.

PLC
"Logic analyzer" service

Time base

The operator may use this parameter to assign the timeframe to each vertical division. The size of these divisions, therefore the resolution of these signals will be determined by this time base. Consequently, the smaller the time base, the greater the signal resolution.

The value is given in milliseconds or microseconds according to the active units and the selected value will be displayed in the information area.

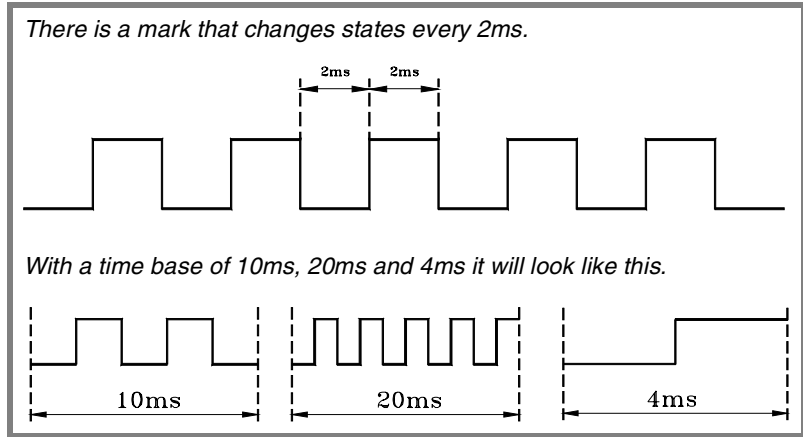

While the graphic window is selected, use the "+" and "-" keys to divide or multiply this time base by two.

Start distance / Trigger distance

This data is only shown when there is a trace.

Start distance	It represents the time difference between the indicator cursor and the base point of the trace (beginning of the trace if there is no trigger point or it has not been reached).
Trigger distance	It represents the time difference between the indicator cursor and the trigger point (if it has taken place).

The value is updated when moving the indicator cursor of the graphic area. Its value may also be edited, thus updating the cursor position in the graphic area.

Reference distance

This data is only shown when there is a trace already and the operator has put a reference signal. It represents the time difference between the indicator cursor and the reference signal.

The value is updated when moving the indicator cursor of the graphic area. Its value may also be edited, thus updating the cursor position in the graphic area.

Trace status

This element cannot be edited, it automatically reflects the status of the trace. The possible messages are:

- Empty.
- Beginning.
- Executing.
- Stopping.
- Full.

10.

PLC
"Logic analyzer" service

10.9.2 Save, load and reset the analyzer configuration

10.

PLC
"Logic analyzer" service

Save the configuration

It is used to save the current configuration of the logic analyzer (PLC variables and expressions, trigger conditions, graphic traces) into a file.

When selecting this option, the CNC shows a list of trace files (TRC) already saved. To save the current configuration:

1. Define the file name at the bottom window. To replace an existing file, select it from the list.
2. Press [ENTER] to save the configuration or [ESC] to return to the logic analyzer without saving the configuration.

Load the configuration

It is used to recover a logic analyzer configuration that has been stored earlier.

When selecting this option, the CNC shows a list of trace files (TRC) already saved. To load one of these files:

1. Define the file name at the bottom window or select it from the list.
2. Press [ENTER] to save the configuration or [ESC] to return to the logic analyzer without loading the configuration.

Initialize the configuration

It is used to reset all the analyzer data eliminating the defined variables or expressions as well as the trigger condition and trigger type. The traces are also deleted because there are no variables to be analyzed.

10.9.3 Execute and analyze trace

Execute trace / Stop trace

It is used to start or stop the data capture to display the traces.

Analyze trace

It is used to analyze the different graphic aspects of the trace.



When selecting this option, the softkey menu shows the options available for analyzing the trace. To return to the main menu, press the key for the previous menu.

- Go to the beginning
It moves the indicator cursor and the current graphic view to the beginning of the trace.
- Go to the end
It moves the indicator cursor and the current graphic view to the end of the trace.
- Go to the time
It moves the indicator cursor and the current graphic view to the time value set by the operator with respect to the base point of the trace (starting point of the trace if there is no trigger or to the trigger point if there is one).
- Go to trigger
It moves the indicator cursor and the current graphic view to the trigger point.
- Go to reference
It moves the indicator cursor and the current graphic view to the reference point defined earlier.
- Set reference
It sets a reference point at the current cursor position for time difference calculation.
- Remove reference
Removes the reference point defined earlier.

Trace view / Edit view

It toggles between the graphic window and the data and display conditions area.

MS (milliseconds) / US (microseconds)

It toggles between milliseconds (0.001^{-3} seconds) and microseconds (10^{-6} seconds).

Print

It is used to print the graph on a printer connected to the CNC or as a BMP file in the CNC. When printing to a file, it is saved in the folder:

"C:\Cnc8070\Mtb\Plc\Watch*.bmp"

10.

PLC
"Logic analyzer" service

FAGOR 

CNC 8070

(SOFT V02.0x)

10.9.4 Customize the appearance of the logic analyzer

It is used to customize the looks of the different elements of the logic analyzer.

When selecting this option, the CNC shows a dialog box with the options available for customizing.



10.

PLC
"Logic analyzer" service

Set aspect

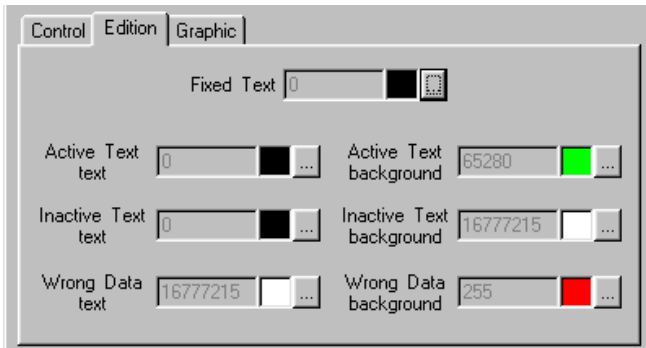
CTRL + 



	<i>To move the cursor through the elements of the list.</i>
SPACE	<i>To show the color palette.</i>
	<i>To select a color from the palette</i>
	<i>Accept the selection in the color palette</i>
ESC	<i>It cancels the selection in the color palette.</i>

After defining the new look, use the cursor to select one of the buttons here below to accept or ignore the changes made and press [ENTER].

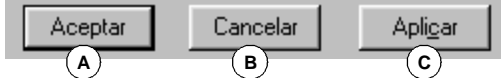

(A) *To accept the changes and close the dialog box.*

(B) *To ignore the changes and close the dialog box.*

(C) *To apply the changes and close the dialog box.*

The dialog box may also be closed directly without accepting the changes by pressing [ESC].

10.10 "Monitoring" service

This service is used to analyze the status of the various PLC variables and resources.

When selecting the "Monitoring" option at the service window, it will show a list with the three resource files used last. This will let you recover one of them without having to define it again.

Pressing the "Show" softkey access the service screen. If a file was selected from the list, it will show the resources defined in it. To close the monitoring window, press [ESC].

10.

PLC
"Monitoring" service

Description of the monitoring service

This service screen is divided into several windows that may be accessed with the window switching key.

The monitoring screen looks like this:

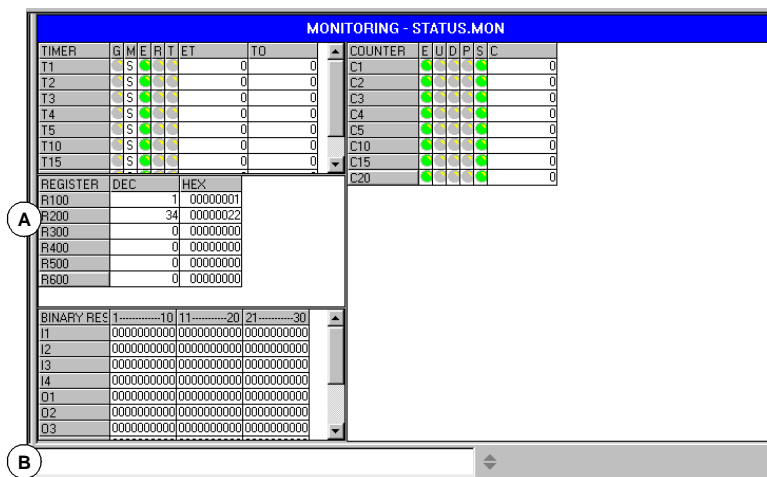

A. Resources selected for monitoring.

It shows the user resources and symbols being analyzed. They are shown grouped in the following tables:

- | | |
|-----------|------------------|
| Timers | Counters |
| Registers | Binary resources |

Each of them shows information on the status of those resources.

B. Data entry area.

It is used to define the user resources and symbols to be analyzed and modify their values by directly assigning a value to them.

Softkey menus

When selecting this service, the horizontal softkey menu will show all the options associated with resource monitoring. The set of options offered by this menu may be changed using the "+" softkey which offers a new set of options.

10.10.1 Description of resource tables

As mentioned earlier, the user resources and symbols defined are displayed in different tables. Each table shows the following information.

Timers

This table shows the timers and user defined symbols for the timers and their status.

This table has the following fields:

- G It indicates whether any of the trigger inputs of the timer is active (TG1, TG2, TG3 or TG4).
- M Timer status:
 - S - Stopped.
 - T - Timing.
 - D - Disabled.
- E Status of the Enable input (TEN).
- R Status of the Reset input (TRS)
- T Status output.
- ET Elapsed time.
- TO Remaining time.

The inputs and outputs that are high will be indicated with a green symbol.

Registers

This table shows the registers and user symbols defined for the registers as well as their values.

The values may be shown in decimal, hexadecimal or binary format.

Binary resources

This table shows the binary resources (inputs, outputs, messages, errors) and the user defined symbols for the binary resources as well as information on their status.

Counters

This table shows the counters and user symbols defined for the counters as well as their status.

This table has the following fields:

- E Status of the enable input (CEN).
- U Status of the Count-up input (CUP).
- D Status of the Countdown input (CDW).
- P Status of the preset input (CPR).
- S Status output.
- C Value of the internal count of the counter.

10.

PLC
"Monitoring" service



CNC 8070

(SOFT V02.0x)

The inputs and outputs that are high will be indicated with a green symbol.

10.

PLC
"Monitoring" service



CNC 8070

(SOFT V02.0x)

10.10.2 Definition of the table resources

Each table shows the following resources and user symbols:

Timer table

- Timers (T1...T256).
- User symbols defined for the timers.

Counter table

- Counters (C1...C256).
- User symbols defined for the counters.

Register table

- Registers (R1...R1024).
- User symbols defined for the registers.
- PLC-CNC register variables.

Binary resource table





- Inputs (I1...I1024) and outputs (O1...O1024).
- Marks (M1...M8192).
- Messages (MSG1...MSG256) and errors (ERR1...ERR256).
- User symbols defined for the binary resources.
- CNC-PLC boolean variables.

When defining a resource or user symbol, it will be added to the corresponding table.

Data entry

The resources and user symbols of the tables are defined at the data entry area. Their values may be changed by directly assigning a value to them (M110=1, R300=34). If it is a hexadecimal value, it must be preceded by the "\$" sign (M10=\$1, R200=\$20).





The window saves the last "N" assignments so they can be recalled later on. In order to make selecting easier, it is possible to display a window with the list of the assignments already made.

Keys for defining the data of the logic analyzer	
 	To select the assignments.
	To assume the selected assignments.
	To show the list of the assignments made.
	To close the list of the assignments made.

10.

PLC
"Monitoring" service

To remove a resource or user symbol from a table, select that element and press [SUP].

Keys for defining the data of the logic analyzer	
	To select one of the tables.
	To moves the cursor element by element.
	To move the cursor page by page in the table.
	To move the cursor to the beginning or end of the table.
	To delete the selected resource of the table.

10.

PLC
"Monitoring" service

10.10.3 Options of the "Monitoring" service (softkeys).

When accessing the "Monitoring" option of the softkey menu, the following options will be available.

Save set

It is used to save the set of defined resources into a file.

When selecting this option, the CNC displays a window with the list of the files (.MON) currently saved. To save a set of defined resources:

1. Define the file name at the bottom window. To replace an existing one, select it from the list.
2. Press [ENTER] to save the program or [ESC] to cancel the selection and close the program listing.

Load set

It is used to recover the set of resources previously saved into a file.

When selecting this option, the CNC shows a window with the list of available files. To load one of these files:

1. Define the file name at the bottom window or select it from the list.
2. Press [ENTER] to load the selected file or [ESC] to cancel the operation and close the program listing.

Binary

It toggles between displaying the register values in decimal and hexadecimal format or only in binary.

Visibility

It shows or hides certain resource tables.

Add row

It increases the size of the active window (where the cursor is) by adding a file to it.

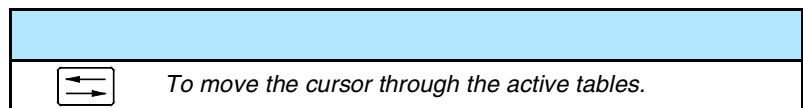

Remove row

It decreases the size of the active window (where the cursor is) by removing a row from it.

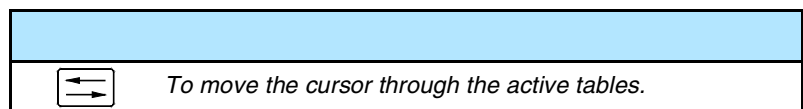

10.

PLC
"Monitoring" service

Data input

It selects the data entry area.

Clear all

It deletes all the resources from the tables.

10.

PLC
"Monitoring" service

FAGOR 

CNC 8070

(SOFT V02.0x)

10.11 "Cross references" service

The "Cross references" service may be used to obtain information about the PLC resources being used in the PLC project.

Pressing the "Show" softkey accesses the window of this service. To close the cross-reference window, press [ESC].

Description

The screen of this service looks like this:

Name	File	Line	Use
AUXEND	plcpra.plc	69	=
BLKSEARCH	plcpra.plc	59	?
	plcpra.plc	60	?
	plcpra.plc	61	?
BLKSKIP1	plcpra.plc	43	=
CYSTART	plcpra.plc	15	=
DM03	plcpra.plc	26	?
DM04	plcpra.plc	27	?
DM05	plcpra.plc	28	?
DM41	plcpra.plc	20	?
DM42	plcpra.plc	21	?
DM43	plcpra.plc	22	?
DM44	plcpra.plc	23	?
DRENA4	plcpra.plc	4	=
DRENA5	plcpra.plc	4	=

- A.** Name of the resources being used by the PLC project.
- B.** File of the PLC project where the resource is being used.
- C.** Line, within the file, containing the resource.
- D.** How the resource is being used.

For the inputs, outputs, marks and registers:

- ? The resource is used as a consultation.
- = The resource is used as an action.

For the timers.

- TG Timer trigger.
- T Status consultation.
- TEN Enable input.
- TRS Reset input.

For the counters.

- C Status consultation.
- CPR Counter preset.
- CEN Enable input.
- CUP Count-up input.
- CDW Countdown input.

10.

PLC
"Cross references" service

10.11.1 Options of the "Cross reference" service (softkeys)

When accessing the "Cross reference" service, the softkey menu will offer the following options:

Inputs

It shows information about the inputs.

Outputs

It shows information about the outputs.

Marks

It shows information about the marks.

Registers

It shows information about the registers.

Timers

It shows information about the timers.

Counters

It shows information about the counters.

Print

It is used to print the cross reference tables out to a printer connected to the CNC or as a "*.PRN" file at the CNC. When printing to a file, it is saved in the folder:

"C:\Cnc8070\Users\Reports*.prn"

When selecting this option, the CNC shows a dialog box requesting the destination for the file (printer or file). When printing to a file, it is possible to select the name and location of the file.

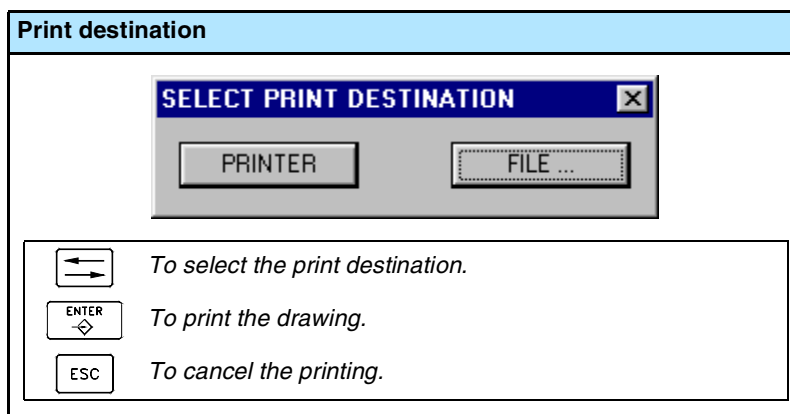

After selecting the destination, press [ENTER] to print the table or [ESC] to cancel it.

10.12 "Statistics" service

The "Statistics" service may be used to obtain information about the execution times of the PLC and the files making up the PLC project.

Pressing the "Show" softkey access the service screen. To close the statistics screen, press [ESC].

Description

The screen of this service looks like this:

STATISTICS				
TIMES	Minimum	Maximum	Medium	Periodicity
CY1	---	---	45 us	---
PRG	16 us	60 us	18 us	8000 us
PLC Process	---	118 us	14 us	4000 us

FILES	Size	Type	Modified
PLCPRG.PLC	2 KB	IL source file	15/12/2000 14:30:32

A. Execution time-table.

This table shows the following data (from left to right):

- Modules making up the PLC program.
- Minimum module execution time.
- Maximum module execution time.
- Average module execution time.
- Module execution frequency.

B. PLC file table.

This table shows the following data (from left to right):

- Files making up the PLC project.
- Size of each file.
- File type.
- Date last modified.

10.

PLC
"Statistics" service

10.12.1 Options of the "Statistics" service (softkeys)

Refresh

It refreshes the table information.

Print

It is used to print the tables out to a printer connected to the CNC or to a file (*.PRN) at the CNC. When printing to a file, it is saved in the folder:

"C:\Cnc8070\Users\Reports*.prn"

When selecting this option, the CNC shows a dialog box requesting the destination for the file (printer or file). When printing to a file, it is possible to select the name and location of the file.

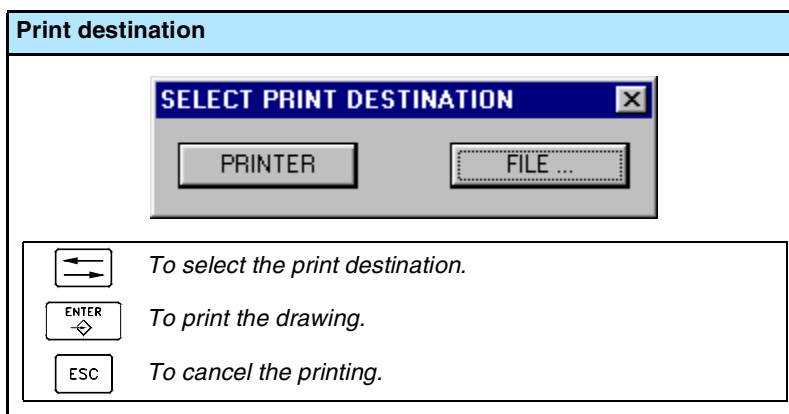

After selecting the destination, press [ENTER] to print the table or [ESC] to cancel it.

10.

PLC
"Statistics" service

10.13 "Messages" service

10.

PLC
"Messages" service

The "Messages" service may be used to edit the texts associated with PLC messages and errors. These files may also be displayed and edited (and thus translated into other languages) using any text editor.

The message and error files are stored in the folder: "C:\CNC8070\MTB\PLC\LANG"\<language>" corresponding to the language active at the CNC. To use messages and errors in other languages, copy the files to the folder of the desired language.

On CNC power-up, the messages and errors are loaded from the folder corresponding to the language active at the CNC.

Pressing the "Show" softkey access the service screen. To close the message window, press [ESC].

Description

This screen shows the messages (MSG) and errors (ERR) defined at the PLC. The screen shows the following table:

MESSAGES AND ERRORS			
A	B	C	D
ID	PLAYED	MESSAGE	REL. FILE
MSG 1	<input type="checkbox"/>	MSG -1-	
MSG 2	<input checked="" type="checkbox"/>	MSG -2-	C:\CNC8070\MTB\PLC\Lang\msg2.bmp
MSG 3	<input checked="" type="checkbox"/>	MSG -3-	C:\CNC8070\MTB\PLC\Lang\msg3.jpg
MSG 4	<input checked="" type="checkbox"/>	MSG -4-	C:\CNC8070\MTB\PLC\Lang\msg4.txt
MSG 5	<input checked="" type="checkbox"/>	MSG -5-	C:\CNC8070\MTB\PLC\Lang\msg5.avi
MSG 6	<input checked="" type="checkbox"/>	MSG -6-	C:\CNC8070\MTB\PLC\Lang\msg6.bmp
MSG 11	<input type="checkbox"/>	MSG -11-	
ERR 1	<input checked="" type="checkbox"/>	ERROR -8-	
ERR 2	<input checked="" type="checkbox"/>	ERROR -7-	
ERR 3	<input checked="" type="checkbox"/>	ERROR -8-	
ERR 4	<input checked="" type="checkbox"/>	ERROR -9-	
ERR 5	<input checked="" type="checkbox"/>	ERROR -10-	

PLC STATUS : RUNNING

A. Message or error identifier.

Number, between 1 and 256, that identifies the message (MSG) or the error (ERR). The numbering needs not be sequential.

B. Display of the additional information files.

It indicates whether to show or not the file for additional information when displaying the message. When it comes to errors, it cannot be edited.

C. Text of the message or error displayed for the user.

D. Address of the additional information file.

It may be a text file (*.txt), image file (*.bmp, *.jpg), a combination of both (*.htm, *.html) or a video (*.avi). When it comes to errors, it cannot be edited because they cannot be assigned an information file.

10.13.1 Options of the "Messages" service (softkeys)

Save

It saves the message and error table into a file in ASCII format (*.MEF).

The contents of the table may be saved at the CNC, in a floppy disk or in another CNC (or PC) via Ethernet.

Load

It recovers the table values saved earlier in the hard disk of the CNC.

Print

It prints the message and error table out to a printer connected to the CNC or as a file (*.PRN format) at the CNC.

New message

It is used to define a new message in the table.

New error

It is used to define a new error in the table.

Select information

It selects the file for additional information.

Delete

It deletes the selected message or error from the table.

10.PLC
"Messages" service

10.13.2 Editing the message and error table

10.

PLC
"Messages" service









Messages

To add a new message to the table, press the "New message" softkey. The CNC adds a new row to the table and it identifies it with the label -MSG-, indicating that it corresponds to a message.

To edit or modify the table data, use the cursor to select the cell whose value is to be changed and define the data as follows:

- The number and text of the message is entered directly from the keyboard.
- The "show" option is turned on and off with the [SPACE] key.
- The file for additional information may be entered directly or may be selected with the "Select Info" softkey.

Keys for defining the data of the logic analyzer

	To move the cursor to the upper, lower, left or right cell.
  	
 	To move the cursor to the beginning / end of the row.
 	To move the cursor to the beginning/end of the column.

Press [ENTER] every time a data is edited to accept the new value or [ESC] to cancel it.

To delete a message from the table, select it with the cursor and press the "Delete" softkey.

Errors

To add a new error to the table, press the "New error" softkey. The CNC adds a new row to the table and it identifies it with the label -ERR-, indicating that it corresponds to an error.

To edit or modify the table data, use the cursor to select the cell whose value is to be changed and define the data as follows:

- The number and text of the error are entered directly from the keyboard.
- The "show" option and the file for additional information cannot be edited.

Press [ENTER] every time a data is edited to accept the new value or [ESC] to cancel it.

To delete an error from the table, select it with the cursor and press the "Delete" softkey.

10.13.3 Displaying PLC messages

When activating a message (marks "MSG1" through "MSG256"), the PLC message window (top right) shows the message number and its associated text. If the message has been defined so it shows a file with additional information, it will be displayed at full screen (if the file does not exist, a blue screen will be displayed).

If there are several active messages, it will display the one with highest priority (the one with lowest number). It will also show the "+" sign next to the PLC message window to indicate that there are more messages activated by the PLC.

Message window

In order to expand the PLC message window and display the active message list, press the key combination [CTRL]+[M]. The list will show a symbol next to each message to indicate that it has a file with additional information associated with it.

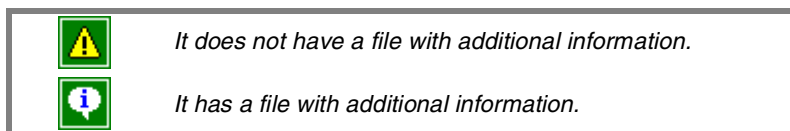







To display a message, select it with the cursor and press [ENTER]. If the message has an additional information file, it will be displayed on the screen. To close the additional information window, press [ESC].

File with additional information







The files with additional information, defined by the machine manufacturer, may be displayed automatically when activating the message (if so defined in the message table) or when requested by the user (at the message window).

The following keys are available to move around in the additional information window depending on the type of file displayed (TXT, BMP, JPG, HTM, HTML or AVI):

- TXT, BMP, JPG, HTM, HTML file.

			To move the window contents up or down one line, one page or everything.
			

- AVI file.

			To stop and moves the video forward or backward 1 frame, 5 frames or the whole video.
			

 To stop the video.

 To play the video.

10.13.4 Displaying PLC errors

When activating an error (marks "ERR1" through "ERR256"), part-program execution is interrupted and the center of the screen displays a window with the error number and its associated text.

Error window

When there is an active error, no other action but deleting it is allowed.

Although the error window disappears from the screen when pressing [ESC], the error state is not eliminated. To get out of the error state, press [RESET].

10.

PLC
"Messages" service

10.13.5 Save, load and print a message and error table

Save table

To save the table data, press the "Save" softkey and the CNC will show a list with the files saved at the CNC.

To save the table data:

1. Select the destination folder.
2. Define the file name at the bottom window. To replace an existing file, select it from the list.
3. Press [ENTER] to save the file or [ESC] to cancel the operation.

The file will be saved with the extension: *.MEF.

Load table

To recover the table data, press the "Load" softkey, the CNC will show a list with the files available at the CNC.

To load the table data:

1. Select the folder where the file is.
2. Select the file or write its name at the bottom window.
3. Press [ENTER] to accept the selection or [ESC] to cancel it and close the file listing.

Print table

It prints the message and error table out to a printer connected to the CNC or as a file (*.PRN format) at the CNC. When printing to a file, it is saved in the folder:

"C:\Cnc8070\Users\Reports*.prn"

When selecting this option, the CNC will show a dialog box requesting the destination for the table (printer or file).

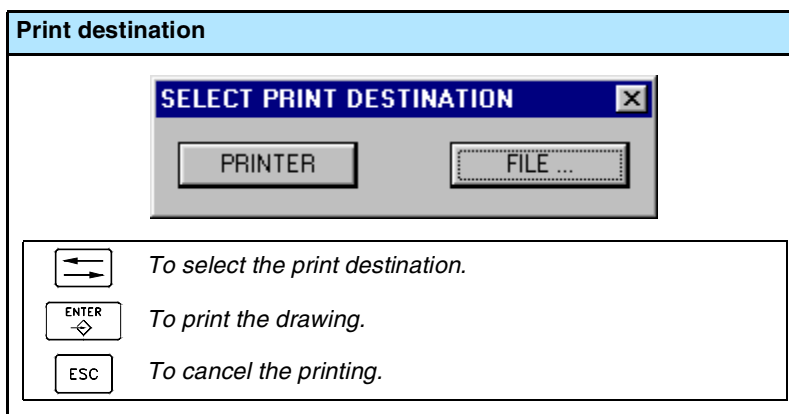

After selecting the destination, press [ENTER] to print the table or [ESC] to cancel it.

10.

PLC

"Messages" service



CNC 8070

(SOFT V02.0x)

In order for the machine tool to be able to properly execute the programmed instructions, the CNC must know the specific data of the machine such as feedrates, accelerations, feedback, automatic tool change, etc.

This data is set by the machine manufacturer and must be defined in the machine parameter table.

▼ Selecting the machine parameter tables



The machine parameter tables may be accessed either using the user key if it has been set accordingly or from the task window. The task window may be accessed with key combination [CTRL]+[A].

▼ What can you do in this work mode?

The machine parameter operating mode offers the following operations:

- Edit and modify the machine parameter tables.
- Validate the machine parameter tables.
- Saving the table contents.
- Recalling the table contents.
- Printing the table contents.
- Initializing the tables.

The machine parameter tables may be edited in this mode or be copied from a floppy disk or other peripheral connected to the CNC via Ethernet.

Parameter setting

To set the machine parameter tables, proceed as follows:

1. Edit the values of the tables.

First, set the general machine parameters because they define the axes of the machine, thus the axis machine parameters.

The general machine parameters can also be used to define the data for the cross compensation.

Use the axis machine parameters to determine whether leadscrew error compensation will be applied or not and define the data of the corresponding table.

2. Validate the table data.

This operation is a must after defining the parameters of the tables and every time any of the data is modified.

3. Save the data of the table.

It is recommended to save the data of the machine parameter table so as to have a backup copy of them. The data may be stored at the CNC, in a floppy disk or at another CNC (or PC) connected through Ethernet.

11.

MACHINE PARAMETERS

11.1 Appearance of the machine parameter tables

When this mode is active, it will be indicated at the top right side of the general status bar.



This operating mode consists of several tables. The various tables may be selected using the horizontal softkeys. If while one of the tables is selected, the previous menu key is pressed, that table will be deselected.

The available machine parameter tables are:

- General parameters.
- Axis and spindle parameters.
- Jog parameters.
- Parameters related to the "M" functions.
- Parameters for kinetics.
- Parameters for the magazines.
- HMI parameters.
- OEM parameters.

Standard configuration

The standard configuration of this work mode, described in this manual corresponds to the one supplied by Fagor. In some cases, the manual shows a sample screen, instead of that of the CNC in order to make it easier to understand.

11.

MACHINE PARAMETERS

Appearance of the machine parameter tables

FAGOR 

CNC 8070

(SOFT V02.0x)

11.1.1 Icon description (vertical softkeys)

The icons are activated with their associated softkey (F8 to F12).



The icon menu offers all the options for the selected table. The group of icons of this menu may be expanded with the softkey associated with the "+" icon that offers a new set of icons.

List of icons



Display units (millimeters/inches)

To toggle between the two types of units used to represent the parameters that depend on those units (coordinates, feedrates, etc.).

The icon highlights the units currently selected (millimeters or inches).



Initialize table

It resets all the parameters to their default values.

The CNC will request confirmation of the command.

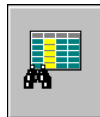

Find text

It is used to find a text or a value in the table.

When selecting this option, the CNC shows a dialog box requesting the text to be found.



Validate table

For validating the table data. If there is no table selected, all the data of all the tables will be validated.

This table is necessary after changing a data. In certain cases, the CNC will have to turned off and back on in order for the data to be validated.



Save tool

It saves the values of the table into a file. If there is no table selected, all the data of all the tables will be saved.

This file may be saved at the CNC, in a floppy disk or at another CNC (or PC) connected through Ethernet.

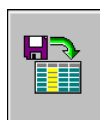

Recall table

It restores the values of the table previously saved into a file. If there is no table selected, all the data of all the tables will be recalled.

11.

MACHINE PARAMETERS
Appearance of the machine parameter tables



Print table

It prints the contents of the table out to a printer connected to the CNC or as a file (*.PRN format) at the CNC.



Activate TEACH-IN

It is used for activating the TEACH-IN work mode in order to set the leadscrew and cross compensation tables.

11.

MACHINE PARAMETERS
Appearance of the machine parameter tables

11.2 Parameter table description

The machine parameter tables have the following structure:

GENERAL PARAMETERS				
Mnemonic	Value	Unit	Limits	Default Value
NAXIS	3		[3..16]	3
AXISNAME				
GANTRY				
NSPDL	1		[0..1]	1
SPDLNAME				
CAXNAME			[1..2 chars]	
GNC				
LOOPTIME	4	ms	[1.0000..20.0000]	4
PREPFREQ	1		[1..4]	1
PRGFREQ	2	cycles	[1..100]	2
SERBRATE	4 Mbps			4 Mbps
CANLENGTH	< 20 m			< 20 m
KINID	0		[0..6]	0
SLOPEYPE	Trapezoidal			Square Sine
Number of axes handles not included				

- A. Name of the selected machine parameter table.
- B. Parameter list.
- C. Parameter value, set by the user.
- D. Units used to define the parameter.
- E. Limit values for the parameter.
- F. Default value of the parameter.
- G. Parameter description.

The section on **"11.3.1 Data editing and validation"** in this chapter shows how to edit the parameters of the tables.

Certain parameters cannot be edited; they only access a set of parameters or a data table. These parameters will be identified as follows.

	To access a group of parameters.
	To access a data table.

To access the data associated with the parameter, select the parameter with the cursor and press [ENTER]. To return to the previous parameter table, press [ESC].



To obtain further information about the data appearing in the table, refer to the chapter on machine parameters of the Installation and Start-up Manual.

11.

MACHINE PARAMETERS
Parameter table description



CNC 8070

(SOFT V02.0x)

11.2.1 "M" function setting table

This table is accessed using the M-function machine parameter "DATA" and it has the following structure:

M FUNCTION TABLE : M VALUES				
Mnemonic	MNUM	SYNCHTYPE	MTIME	MPROGNAME
DATA 1		Before-Before ▼	0	
DATA 2		Before-Before ▼	0	
DATA 3		Before-Before ▼	0	
DATA 4		Before-Before ▼	0	
DATA 5		Before-Before ▼	0	
DATA 6		Before-Before ▼	0	
DATA 7		Before-Before ▼	0	
DATA 8		Before-Before ▼	0	
DATA 9		Before-Before ▼	0	
DATA 10		Before-Before ▼	0	
DATA 11		Before-Before ▼	0	
DATA 12		Before-Before ▼	0	
DATA 13		Before-Before ▼	0	
DATA 14		Before-Before ▼	0	

M function number

- A. Name of the selected machine parameter table.
- B. Order number.
- C. List of user defined "M" functions.
- D. Type of synchronism.
- E. Time for execution time estimate.
- F. Associated subroutine.
- G. Parameter description.

The section on **"11.3.1 Data editing and validation"** in this chapter shows how to edit the parameters of the tables.



To obtain further information about the data appearing in the table, refer to the chapter on machine parameters of the Installation and Start-up Manual.

11.

MACHINE PARAMETERS
Parameter table description



CNC 8070

(SOFT V02.0x)

11.2.2 Compensation table

There are two types of compensation table:

- Leadscrew error compensation, which is accessed with the axis machine parameter "COMPENSATION".
- Cross compensation, which is accessed with the general machine parameter "CROSS COMP".

These compensation tables have the following structure:

GENERAL PARAMETERS : CROSS COMPENSATION 1 VALUES			
Mnemonic	POSITION	POSERROR	NEGERROR
CROSS COMP 0	12.2409	0.5849	0.3541
CROSS COMP 1	15.7370	0.4511	0.5240
CROSS COMP 2	21.2319	0.3257	0.8409
CROSS COMP 3	28.2250	0.5417	0.9840
CROSS COMP 4	35.2180	0.6659	0.9840
CROSS COMP 5	38.9840	15.0000	0.9840
CROSS COMP 6	38.9810	0.6840	0.8970
CROSS COMP 7	44.7079	0.6780	0.1409
CROSS COMP 8	48.2049	0.4683	0.9799
CROSS COMP 9	50.4690	0.9869	0.9847

Valor de corrección

- A. Name of the selected machine parameter table.
- B. Compensation point.
- C. User defined axis position.
- D. Amount of error to compensate in the positive direction.
- E. Amount of error to compensate in the negative direction.
- F. Parameter description.

The section on "[11.3.1 Data editing and validation](#)" in this chapter shows how to edit the parameters of the tables.



To obtain further information about the data appearing in the table, refer to the chapter on machine parameters of the Installation and Start-up Manual.

11.

MACHINE PARAMETERS
Parameter table description

11.3 Operations with tables



11.3.1 Data editing and validation

Use the softkey menu to select the desired machine parameter table. To edit the table data, proceed as follows:

1. Use the cursor to select the parameter whose value is to be set.
2. Key in the desired value. If [SUP] is pressed, the parameter will assume the default value.
3. Press [ENTER] to accept the new value or [ESC] to ignore the new value and recover the previous one.

Parameter types

Certain parameters can only assume specific values. These parameters will be identified as follows.

	<i>The parameter has a list of options.</i>
	<i>The parameter refers to a file.</i>

Depending on the type of values they can assume, they will be defined as follows:

- If the parameter may assume a value between specific limits, enter the desired value.
If the value exceeds those limits, the parameter will assume its default value.
- If the parameter contains a list of options, press [ENTER] to display the drop list and select one of those options.
- If the parameter refers to a file, press [ENTER] and the CNC will show the list of available files.

Data validation.



After editing or modifying the table data, the new values must be validated so they are assumed by the CNC. To validate the data, press the VALIDATE icon.

To validate certain parameters, restart the CNC. These parameters will be identified with the following symbol next to their name:

	<i>Restarting the CNC required.</i>
---	-------------------------------------

11.

11.3.2 Save and recall tables

11.

MACHINE PARAMETERS
Operations with tables

Saving a table

It may be used to save the table data, in ASCII format, in a file.

Use the softkey menu to select the table whose data is to be saved. If no table is selected, all the data of all the tables will be saved.



After selecting the table whose data is to be saved, press the SAVE icon and the CNC shows a list with the tables that are already saved.

Keys for selecting a data file



To switch windows.



To close and open a folder submenu.



To move the cursor thru the elements of the window.



To save the new program.



To cancel the selection and close the programs listing.

To save the table data, proceed as follows:

1. Select the destination folder.
2. Define the file name at the bottom window. To replace an existing file, select it from the list.
3. Press [ENTER] to save the file or [ESC] to return to the tables without saving the file.

The files are saved with the extension *.MP.

Recall a table

It may be used to restore the table data, in ASCII format, from a file.

Use the softkey menu to select the table whose data is to be recalled (restored). If no table is selected, all the data of all the tables will be recalled.



After selecting the table whose data is to be restored, press the LOAD icon and the CNC shows a list with the tables that are already saved.

To recall the table data, proceed as follows:

1. Select the folder containing the file.
2. Select the file from the list or write its name in the bottom window.
3. Press [ENTER] to recall the data or [ESC] to return to the tables without recalling the data.

11.3.3 Find text

It is used to find text or a value in the table.

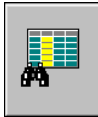

To perform the search, press the FIND icon and the CNC will show a dialog box requesting the text or value to be searched. It is also possible to select whether the search must start at the beginning of the table or at the current cursor position.

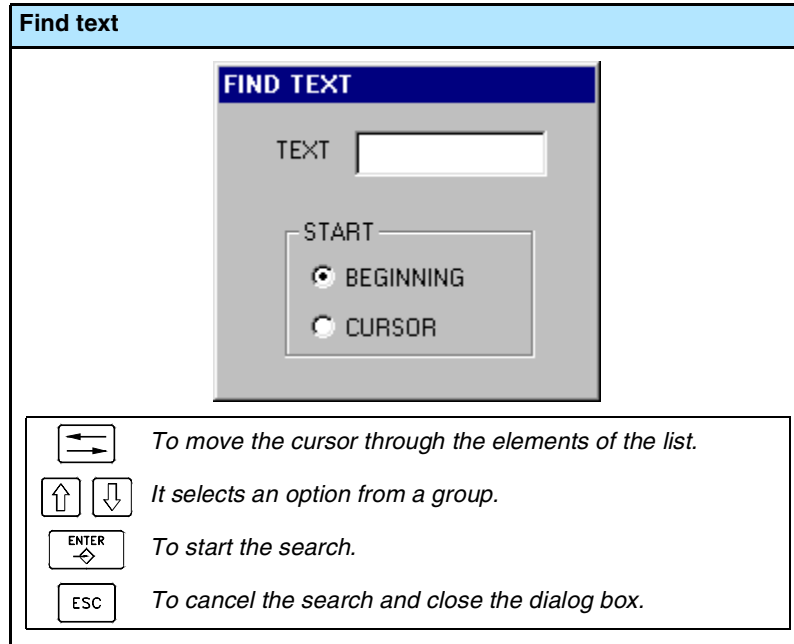

To start the search, press [ENTER] and the cursor will position on the text found. Pressing this FIND icon again will allow repeating the search or defining a new one.

11.

MACHINE PARAMETERS
Operations with tables

11.

MACHINE PARAMETERS

Operations with tables



CNC 8070

(SOFT V02.0x)

The set of utilities of the setup assistance is meant to speed up and simplify the machine setup procedure. The setup assistance offers the following utilities.

- The oscilloscope.
- The circularity (roundness) test.
- The bode diagram.

It must be borne in mind that these utilities are assistance tools that only show the system's response to the various adjustments; it is always up to the technician to choose the best adjustment.

The oscilloscope

The oscilloscope is an assistance tool for adjusting the CNC and the drives. This utility can graphically show 4 previously selected variables, modify their values and check the different responses of the system.

Using the oscilloscope, it is possible to edit the CNC's machine parameters that affect the adjustment; it is also possible to modify at the Sercos[®] drives the variables that have writing permission. In any case, a protection password is required for modifying the CNC's machine parameters or the drive's variables.

The Bode diagram

The Bode diagram is an assistance tool for adjusting the CNC and the drives. This utility may be used to obtain the Bode diagram of the response amplitude depending on the frequency of the input signal.

With this tool, it is possible to insert a sinusoidal signal into an axis, so that changing the frequency and analyzing the response provides the behavior of the axes at different frequencies and will give the user an idea of how it behaves with any signal.

This diagram may be used to check the system's gain, the bandwidth and the mechanical resonance. All this helps achieve the proper adjustment of the loops, analyze mechanical problems and check the final features.

The circularity (roundness) test

This tool helps improve and adjust the axis reversal peak, an effect that appears when the axes reverse their moving direction. With this utility, a circle may be executed with the axes and graphically show the result. This graphic shows the difference between the actual (real) coordinate obtained from the feedback device and the theoretical coordinate calculated at each point.

The same screen showing the graphics also shows the machine parameters that affect the movement reversal. These parameters may be modified while running the test, thus being possible to evaluate the response of the system to these changes and optimize the adjustment on the go.

12.

SETUP ASSISTANCE



CNC 8070

(SOFT V02.0x)

Selection of setup assistance



Setup assistance may be accessed either using the user key if it has been set accordingly or from the task window (by selecting the *Tuning* option). The task window may be accessed with key combination [CTRL]+[A].

The different tools are accessed from the horizontal softkey menu.



The oscilloscope.



The Bode diagram.



The circularity (roundness) test.

12.

SETUP ASSISTANCE

12.1 Oscilloscope

12.

SETUP ASSISTANCE
Oscilloscope

The oscilloscope is an assistance tool for adjusting the CNC and the drives. This utility can graphically show 4 previously selected variables, modify their values and check the different responses of the system.

Using the oscilloscope, it is possible to edit the CNC's machine parameters that affect the adjustment; it is also possible to modify at the Sercos® drives the variables that have writing permission. In any case, a protection password is required for modifying the CNC's machine parameters or the drive's variables.

The oscilloscope is an assistance tool that only shows the response of the system to the various settings (adjustments); it is up to the technician to choose the best adjustment.

How to access the oscilloscope



The oscilloscope may be accessed from the softkey menu for setup assistance.

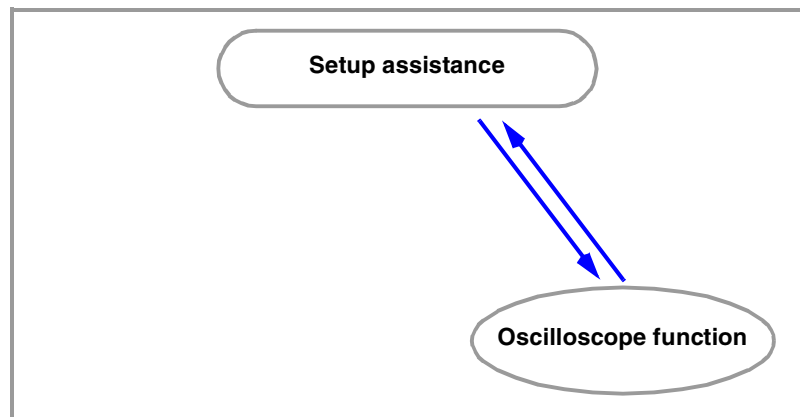

This utility is one of the features of setup assistance. Together with the circularity test and the bode diagram, it helps speed up and simplify the machine setup process.



The oscilloscope function requires Sercos communication and a drive version V06.01 or later. Otherwise, the CNC will show the error "Access denied".

12.1.1 Interface description

The screen of the oscilloscope function looks like this, with two clearly different parts. The left side and the lower side show the data of the variables to be shown, the trigger data, the time base and the parameters that may be acted upon. The top right side shows the variables graphically.

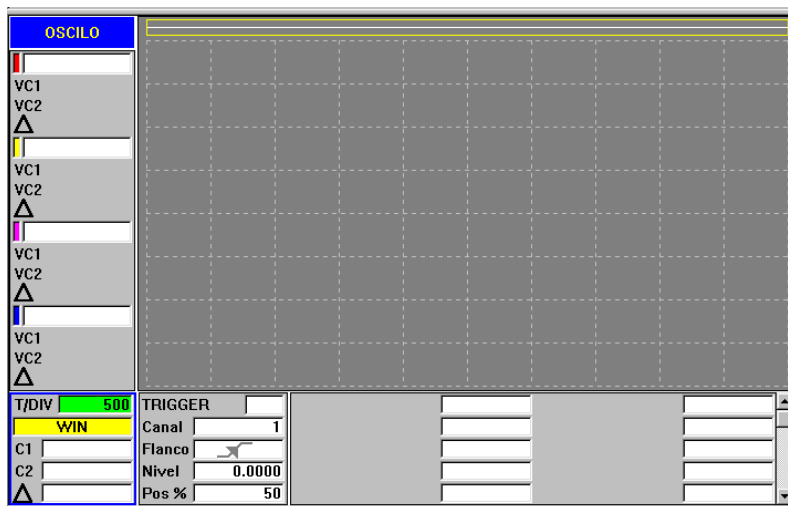

12.

SETUP ASSISTANCE
Oscilloscope

The graphics window

It is the area showing a graphic representation of the selected variables. For each variable, it shows the scale used to draw it.

The data area

It is the area where the user interacts with the system. It allows defining the graphic environment, the variables to be display, the trigger configuration, the time base configuration and the values of the parameters involved.

Some of this data may also be defined at the configuration screen. See "[Configuration screen](#)" en la página 291.

Variables to be displayed

It is the area where the user select the variables to be shown in the graphics window. Up to 4 variables may be displayed at the same time.

This window does not allow selecting the color of each variable being displayed.



To change the color of any variable, it must be done at the configuration screen.



CNC 8070

(SOFT V02.0x)

12.

SETUP ASSISTANCE
Oscilloscope

Trigger data

In this area, the user may select the trigger conditions. The options offered by this trigger data area are:

Trigger

It indicates when the data capture begins.

If not selected, the data capture begins as soon as the user gives the command to begin. The "Flank", "Level" and "Position" data are ignored.

If selected, the trigger condition must be specified with the "Flank", "Level" and "Position" data.

Channel

It indicates which variable or channel (CH1, CH2, CH3, CH4) is to be used as reference or trigger condition.

Flank

It may be up-flank (leading edge) or down-flank (trailing edge).

It is taken into account when trigger has been selected.

Trigger level

It sets the value to be assumed by the variable to start capturing data.

It is taken into account when trigger has been selected.

Position (%)

It is taken into account when Trigger has been selected.

It is defined as a percentage, between 0% and 100%. It indicates the number of samples to be taken before the Trigger. For example, a 10% position indicates that 10% of the total number of programmed samples will be taken before the Trigger and the remaining 90% after that instant.

The Trigger condition is evaluated after gathering the indicated % of samples. If the position is defined as 50% and the Trigger condition takes place after taking 10% of the samples, it is ignored until capturing 50% of the samples.

Machine parameters to be set

In this area of the data window, it is possible to directly change the values of up to 20 machine parameters to be adjusted.

▼ Softkey menu

Horizontal softkey menu

The horizontal softkey menu offers the following options:

❑ Softkey CONFIG

It access the configuration screen. It may be used to define which variables will be displayed, their scale, colors, time base, the Trigger, the trigger condition, the parameters to act upon, etc.

❑ Softkey DATA

It accesses the data processing submenu. This submenu serves to save and load the captured trace as well as the configuration defined for it.

It may also be used to send data of the captured trace out to printer or to a file.



❑ Enlarge screen

With this option, it is possible to enlarge the graphics window to the left, using the area that shows the variables to be displayed. Pressing the same softkey returns the screen to the previous size.

❑ Softkey OVERLAP CHANNELS

Wit this option, several channels may be overlapped.

When this option is selected, the softkey color changes to red.

❑ Softkey AUTOSCALE

When autoscaling a channel, the system determines the proper vertical scale and offset so the signal appears as enlarged as possible inside its graphic area.



❑ Softkey FREEZE SCREEN

The display is "frozen" without interrupting the data capture. When this option is selected, the softkey shows "Resume".



This softkey only appears on the horizontal softkey menu if the capture is in continuous mode. To set the capture in continuous mode, change the "mode" option of the configuration screen.



❑ Softkey BEGIN CAPTURE

Start taking data to show it graphically.

When this option is selected, the softkey shows "Stop".

12.

SETUP ASSISTANCE
Oscilloscope

Vertical softkey menu

Depending on which data has the focus, the vertical softkeys show different options.

Focus on a variable of a channel

When the focus is on any of the variables, the vertical softkeys will be:

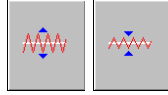

The scale of the graphic may be changed with the "scale" softkeys. The new scale value will appear on the graphic next to the corresponding variable.

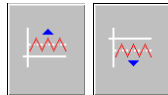

The graphics of the desired channel may be moved up and down using the offset softkeys.



This softkey may also be used to center the graphics.



When the focus is on any of the variables, a new variable name may be either keyed in or selected without having to go to "CONFIG".

Focus on the "WIN" field

With win, it shows the oscilloscope window where it is. When the focus is on this field, the vertical softkeys will be:



It takes the window to the beginning.



It takes the window to the end.



It takes the window to the trigger. If there is no trigger, it will go to the center of the window.



Moves the window to the left.



Moves the window to the right.

12.

SETUP ASSISTANCE
Oscilloscope

Focus on the "C1" or "C2" field

Cursors "C1" and "C2" may be used to analyze each signal of the last data capture.

These two cursors may be used to obtain the position in milliseconds of each signal and the time difference between them "Δ".

When the focus is on one of the fields "C1" or "C2", the following vertical softkeys will appear.



Takes the cursor to the beginning.



Takes the cursor to the end.

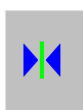

Takes the cursor to the trigger. If there is no trigger, it will go to the center of the window.



Moves the cursor to the left.



Moves the cursor to the right.

Focus on the "T/Div" field

When the focus is on the "T/Div" field, the following softkeys will appear.



Using the autoscale softkey, the oscilloscope selects the right time scale so the signal appears as large as possible inside its corresponding graphic area.

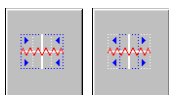

It increases or decreases the time scale.

12.

SETUP ASSISTANCE
Oscilloscope

Focus on the "parameter name" field

As with variables, by selecting the various parameters, it is possible to change their names and values.

When pressing "Enter" after changing the name of a parameter, use the up, down, left and right arrow keys to move the focus to the next field to change the value of that parameter. After changing the parameter value and pressing "Enter", the focus does not go on to the next field. Use the arrow keys to go on to the next parameter.

When the focus is on this field, the 4 vertical softkeys will be:

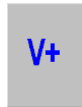

It increases the value of the parameter in the amount indicated on the configuration screen.



It decreases the value of the parameter in the amount indicated on the configuration screen.



It resets the parameter to its default value.



It validates the value given to the parameter.



From the "CONFIG" mode, a screen may be accessed where it is possible to define the list of parameters to be displayed.

12.1.2 Configuration screen

The configuration screen may be accessed with the horizontal softkey "CONFIG".

This screen looks like this with two clearly different areas. The left side shows the data of the variables to be displayed, the trigger data and the time base. The right side shows the parameters to be acted upon and the amount to increase/decrease the values of those parameters.

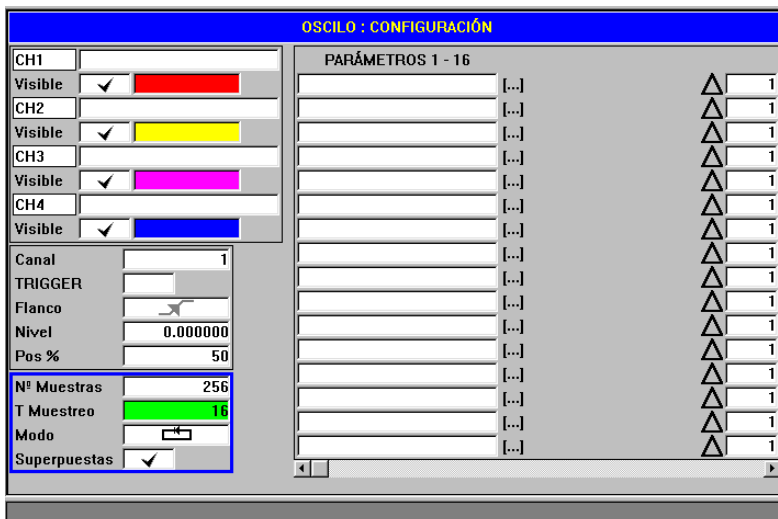

Selection of the variables to be displayed, trigger and time base

It is the area where the user selects the variables to be displayed at the graphics window, the trigger options and the time base. Up to 4 variables may be displayed at the same time.

When typing the name of any variable incorrectly, the CNC will show the error "Access denied".

Besides the trigger data and the base time, this window may be used to select the color used to display the variable and whether it will be visible or not.

Parameter selection and increase/decrease

It is the area where the user selects the parameters upon which to act. To the right of each parameter, there is a square used to increase/decrease of its value.

This way, when the focus is on the value of a variable on the main screen, pressing the vertical softkey "V+" will increase the parameter value in the amount set on the configuration screen.

By default, the increase/decrease value of a parameter is initialized to 1.

12.

SETUP ASSISTANCE
Oscilloscope



CNC 8070

(SOFT V02.0x)

12.1.3 Configure and execute the oscilloscope function

In the oscilloscope mode, from a single screen, it is possible to select the variables to be analyzed, the trigger conditions and the machine parameters of the CNC or the drive that may be modified.

12.

SETUP ASSISTANCE
Oscilloscope

Operating procedure

Execute a part-program to move the axis or axes to be adjusted. Once the program is running, go into the adjustment mode and access the oscilloscope function.

Define the variables to be analyzed, the trigger conditions and the machine parameters of the CNC or the drive that may be modified.



When capturing 1 or 2 variables of the same drive, the capture will be done by the drive itself and the CNC will be in charge of drawing the results.

When capturing more than 2 variables or 2 variables from different drives, in order to synchronize data, the capture will be done by the CNC and the sampling period will be the CNC's cycle time.

Data capture and later analysis of the data.

Once the data capture has been interrupted or completed, it is possible to analyze the signals and modify the parameters that have been previously selected in order to improve the machining conditions.

Repeat the capture, the analysis and the modification of parameters until obtaining the best machining conditions.

Recommendations

Execute endless repetitive movements.

After adjusting the axes individually, readjust the interpolating axes together.

The user must determine which is the best adjustment, the oscilloscope function is just an assistance tool.

Operation

To enter or modify a data on the screens, it must be selected; in other words, it must have the editing focus on it.

Use the [up] and [down] keys to select another editable data or field. It is a rotary selection, if the [up] key pressed when the first element of the screen is selected, the focus goes to the last element whereas if the [down] is pressed when the last element is selected, the focus goes to the first element.

Not all the fields are editable, only the ones that may be selected can be edited, those having the focus. There are two types of editable fields:

□ Editable values:

They may be assigned a value, either a two-digit number or alphanumeric (numbers and letters). Before validating the data, it is checked out and if it is not correct, it will not be accepted and a warning message will be issued.

□ Values that may be selected:

The possible data are fixed one of them must be selected. Use the [right] [left] keys to see the possible values. For this type of values that are icons, the [White/Green] key has the same effect as the [right] key.

12.

SETUP ASSISTANCE
Oscilloscope

FAGOR 

CNC 8070

(SOFT V02.0x)

12.1.4 Machine parameter editing

Here is a list of machine parameters and variables of the drive that may be modified from the oscilloscope.

The new values are assumed by the CNC after pressing [ENTER] and they are maintained until the unit is turned off. Once the setup is completed, the changes must be saved so they can be effective next time the CNC is turned on.



Use the VALIDATE softkey to save the data. The CNC saves the new values in the CNC tables and/or in the drive tables accordingly.

12.

SETUP ASSISTANCE
Oscilloscope

Axis or spindle machine parameters that may be edited

CNC	Drive	Associated variable	Update
PRELOAD		MPG.PRELOAD[tandem]	Immediate
PRELFITI		MPG.PRELFITI[tandem]	Immediate
TPROGAIN		MPG.TPROGAIN[tandem]	Immediate
TINTIME		MPG.TINTIME[tandem]	Immediate
TCOMPLIM		MPG.TCOMPLIM[tandem]	Immediate
INPOSW		MPA.INPOSW.[set].axis	Immediate
BACKLASH	PP58	MPA.BACKLASH.[set].axis	Immediate
G00FEED		MPA.G00FEED.[set].axis	Beginning of next block
MAXVOLT		MPA.MAXVOLT.[set].axis	Immediate
PROGAIN	PP104	MPA.PROGAIN.[set].axis	Immediate
FFGAIN	PP216	MPA.FFGAIN.[set].axis	Immediate
MANFFGAIN	PP216	MPA.MANFFGAIN.[set].axis	Immediate
ACFWFACTOR		MPA.ACFWFACTOR.[set].axis	Immediate
ACFGAIN	PP217	MPA.ACFGAIN.[set].axis	Immediate
MANACFGAIN	PP217	MPA.MANACFGAIN.[set].axis	Immediate
LACC1		MPA.LACC1.[set].axis	Beginning of next block
LACC2		MPA.LACC2.[set].axis	Beginning of next block
LFEED		MPA.LFEED.[set].axis	Beginning of next block
ACCEL	PP42	MPA.ACCEL.[set].axis	Beginning of next block
DECEL	PP42	MPA.DECEL.[set].axis	Beginning of next block
ACCJERK		MPA.ACCJERK.[set].axis	Beginning of next block
DECJERK		MPA.DECJERK.[set].axis	Beginning of next block
ESTDELAY		MPA.ESTDELAY.[set].axis	Immediate
SERVOOFF		MPA.SERVOOFF.[set].axis	Immediate
MINANOUT		MPA.MINANOUT.[set].axis	Immediate
BAKANOUT	PP2	MPA.BAKANOUT.[set].axis	Immediate
BAKTIME	PP3	MPA.BAKTIME.[set].axis	Immediate

The previous table indicates that some parameters will be assumed at the beginning of the next block. For this to be so, the instruction "#SYNC POS" must be programmed after each motion block.



CNC 8070

(SOFT V02.0x)

If the machine parameters are protected, when accessing any of them, the CNC will display a window requesting a password.

12.

SETUP ASSISTANCE
Oscilloscope

FAGOR 

CNC 8070

(SOFT V02.0x)

Variables that may be modified at the Sercos drive

12.

SETUP ASSISTANCE
Oscilloscope

Drive	Name	Update
CP1	CP1.axis	Immediate
CP2	CP2.axis	Immediate
CP3	CP3.axis	Immediate
CP30	CP30[set].axis	Immediate
CP31	CP31[set].axis	Immediate
CP32	CP32[set].axis	Immediate
NP1	NP1.axis	Immediate
RP1	RP1.axis	Immediate
RP2	RP2.axis	Immediate
RP3	RP3.axis	Immediate
RP4	RP4.axis	Immediate
RP51	RP51.axis	Immediate
RP52	RP52.axis	Immediate
RP53	RP53.axis	Immediate
RP54	RP54.axis	Immediate
SP1	SP1[set].axis	Immediate
SP2	SP2[set].axis	Immediate
SP50	SP50.axis	Immediate
SP51	SP51.axis	Immediate
TP10	TP10.axis	Immediate
TP11	TP11.axis	Immediate
TP12	TP12.axis	Immediate
TP13	TP13.axis	Immediate
TP14	TP14.axis	Immediate

Besides the parameters shown in the previous table, the user may access any variable having a writing permission if he knows its name. To do this, use the following nomenclature:

Indicate the axis, the name of the parameter and the set separated by a period.

When modifying any parameter of the previous table, the change is effective immediately without having to reset or restart the unit even when there is a program in execution.

The drive parameters modified with this method are functional immediately, but these values will be lost when the drive is turned off. Use the "Save to flash" option to maintain the modified values of those machine parameters.



CNC 8070

(SOFT V02.0x)

Saving, loading and resetting the configurations

When defining a new configuration of variables to be displayed and parameters modified at the oscilloscope, the system allows saving that configuration into a file.

Likewise, the system allows loading a configuration that was saved previously or resetting the current configuration.

Save

To save the current configuration, go to the configuration screen and press the "Save" softkey.

After this, a new screen appears showing the available configurations with the focus on the last one.

Also, it is possible to rename the new configuration whose extension must be ".osc".

Load

To load a previously saved configuration, go to the configuration screen and press the "Load" softkey.

Then, a new screen appears showing a list of previously saved configurations, being possible to select any of them.

Reset

Pressing the "Reset" softkey of the configuration screen deletes or initializes the current configuration. There are neither variables nor parameters selected and the rest of conditions (colors, trigger, etc.) assume the values assigned by default.

12.**SETUP ASSISTANCE**
Oscilloscope**FAGOR** **CNC 8070**

(SOFT V02.0x)

12.2 The Bode diagram

The Bode diagram is an assistance tool for adjusting the CNC and the drives. This utility may be used to obtain the Bode diagram of the response amplitude depending on the frequency of the input signal.

With this tool, it is possible to insert a sinusoidal signal into an axis, so that changing the frequency and analyzing the response provides the behavior of the axes at different frequencies and will give the user an idea of how it behaves with any signal.

This diagram may be used to check the system's gain, the bandwidth and the mechanical resonance. All this helps achieve the proper adjustment of the loops, analyze mechanical problems and check the final features.

The Bode diagram is an assistance tool that only shows the response of the system to the various settings (adjustments); it is up to the technician to choose the best adjustment.

How to access the Bode diagram



The Bode diagram may be accessed from the softkey menu for setup assistance.

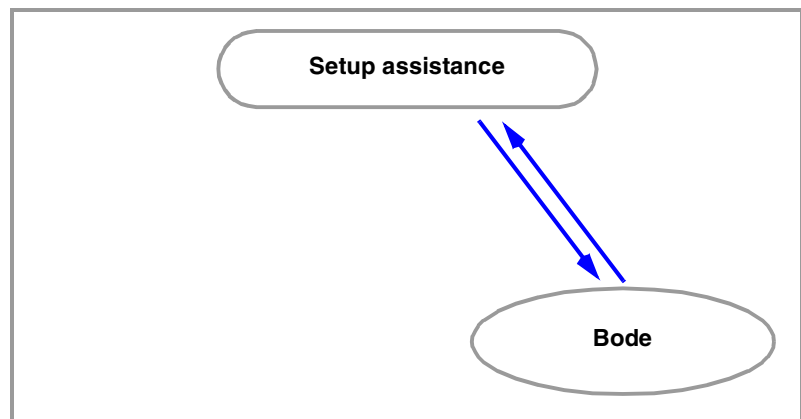

12.

SETUP ASSISTANCE
The Bode diagram

12.2.1 Interface description

The Bode screen looks like this with a single area for the graphics window that shows the Bode diagram.

Besides the Bode diagram, the graphics window shows in dark blue the maximum and minimum gains, in black the gain and frequency values of each line of the grid and in light blue the maximum and minimum values obtained when analyzing the axis

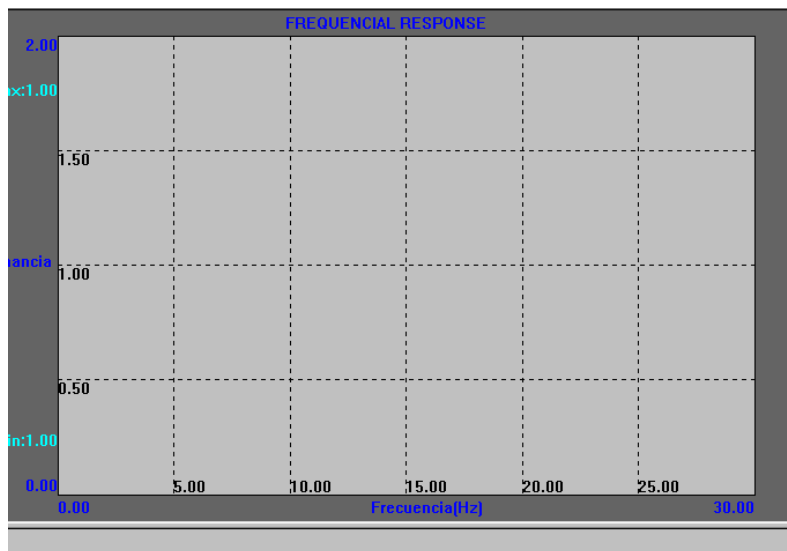

The colors mentioned earlier for the different data shown on the screen are the default ones. Use the "Options" softkey to change them.

12.

SETUP ASSISTANCE
The Bode diagram

Softkey menu

There are some horizontal and vertical softkeys for changing the various options:

Horizontal softkey menu

The horizontal softkey menu offers the following options:

❑ Softkey ANALYZE AXIS

This softkey begins the estimation of the frequency response of the selected axis by means of the options.

❑ Softkey END ANALYSIS

This softkey ends the estimation of the frequency response of the selected axis by means of the options.

❑ Softkey PRINT

This softkey serves to send the Bode graph as a bitmap out to a printer or to a file. This makes it possible to print the screen. The border is removed when printing the screen.

❑ Softkey CLEAR SCREEN

This softkey initializes the graphics.

❑ Softkey DIMENSIONS

This softkey serves to modify the maximum and minimum gains represented in the graphics.

Pressing this options displays a new menu with two horizontal softkeys.

1. Softkey EDIT

This softkey serves to edit the limit values.

2. Softkey AUTOMATIC

This softkey adjusts the limits to the maximum and minimum values obtained from analyzing the axis.

12.

SETUP ASSISTANCE
The Bode diagram

Softkey OPTIONS

This softkey serves to configure the data for the analysis and the way the graphics will look. This option gives access to the following configuration windows:

1. Parameters window:

This window may be used to configure the data used to analyze the axes.

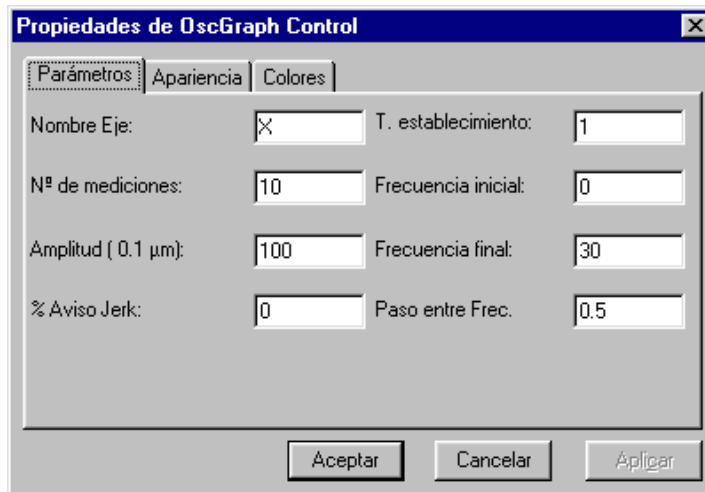

These data are:

Axis name: Name of the axis to be analyzed.

Number of measurements: Number of measurements for each frequency (it shows the average between the maximum and the minimum response amplitudes of each repetition)

Amplitude: Amplitude of the sinusoidal signal that is generated.

% Jerk warning: Factor over the jerk parameter to issue the "jerk exceeded" warning.

Settle T.: Waiting time from when it starts generating the signal for each frequency until the data is being taken into account.

Initial frequency: Frequency from which the analysis begins.

Final Frequency: Last frequency being analyzed.

Pitch between Freq: The frequency being analyzed is incremented with this pitch (step) from the initial frequency until exceeding the final one thus completing the analysis.

12.

SETUP ASSISTANCE
The Bode diagram

12.

SETUP ASSISTANCE
The Bode diagram

2. Aspect window:

This window serves to configure the way the graphics will look.



The fields that may be configured are:

Grid: Display/Hide the grid.

NumGridX: Number of horizontal lines of the grid.

NumGridY: Number of vertical lines of the grid.

Title: Title of the graph.

Log: Gain in decibels and logarithmic representation in frequency.

3. Colors window:

This window serves to configure the colors of the graphics.

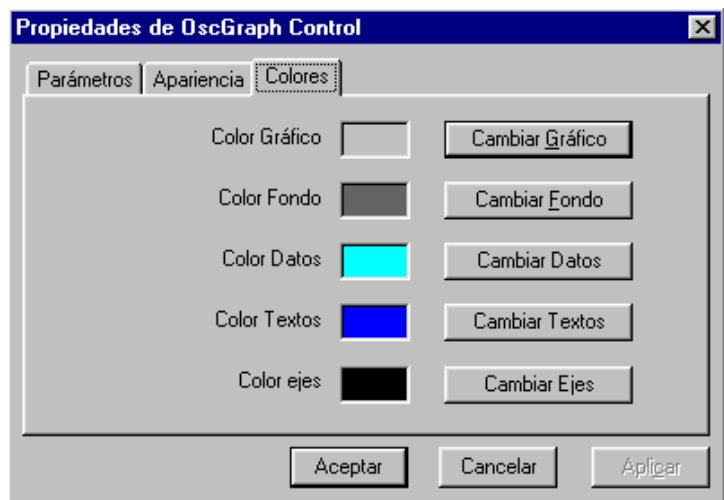

Graphics color: Background color of the graph.

Background color: Background color of the control.

Data color: Color of the captured data.

Text color: Text color of the graph.

Axis color: Grid color.

Vertical softkey menu

When defining a new configuration, the system permits saving that configuration in a file. Likewise, the system permits loading a previously saved configuration.

The vertical softkey menu offers the options to save and load configurations:



□ Softkey SAVE

Press the "save" softkey to save the current configuration.

After this, a new screen appears showing the available configurations.

It is also possible to rename the new configuration.



□ Softkey LOAD

Press the "load" softkey to load a previously saved configuration.

Then, a new screen appears showing a list of previously saved configurations, being possible to select any of them.

12.

SETUP ASSISTANCE
The Bode diagram

12.3 The circularity (roundness) test

12.

SETUP ASSISTANCE
The circularity (roundness) test

This tool helps improve and adjust the axis reversal peak, an effect that appears when the axes reverse their moving direction. With this utility, a circle may be executed with the axes and graphically show the result. This graphic shows the difference between the actual (real) coordinate obtained from the feedback device and the theoretical coordinate calculated at each point. This difference is shown projected radially.

The same screen showing the graphics also shows the machine parameters that affect the movement reversal. These parameters may be modified while running the test, thus being possible to evaluate the response of the system to these changes and optimize the adjustment on the go.

The circularity (roundness) test diagram is an assistance tool that only shows the response of the system to the various settings (adjustments); it is up to the technician to choose the best adjustment.

How to access the circularity (roundness) test



The circularity (roundness) test may be accessed from the softkey menu for setup assistance.

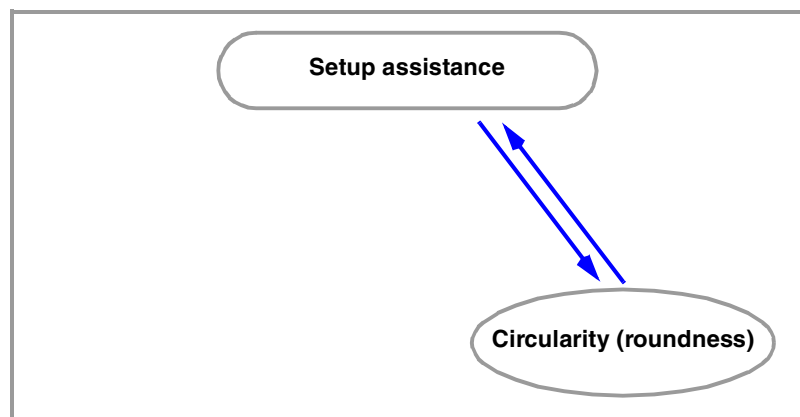

12.3.1 Interface description

The screen of the circularity test looks like this, with two clearly different parts. A graphics window that shows the result of the test and a data area for interacting with the system.

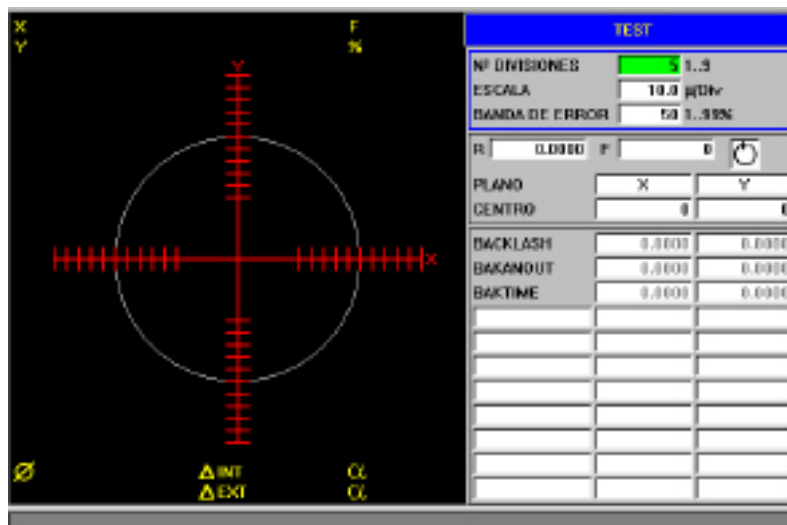

12.

SETUP ASSISTANCE
The circularity (roundness) test

▼ The graphics window

It is the area that shows, graphically, the result of the test.

The graphic shows the two moving axes and the theoretical circle of the interpolation that will be carried out. As the test is being run, the positioning error at each point is drawn on the circle. This error is shown projected radially.

Superimposed on the graphics, it shows the following additional data that is updated by the CNC.

- The real coordinates of the axes.
- Programmed feedrate and % applied.
- Diameter of the displayed circle.
- Maximum and minimum error over the theoretical radius and angular position where it has been detected.

FAGOR 

CNC 8070

(SOFT V02.0x)

The data area

It is the area where the user interacts with the system. It offers a set of data for defining the graphic environment, the subroutine that will be used to generate the machine movement and the machine parameters involved in the adjustment. Selecting one of the data frames the group of parameters it belongs to.

12.

SETUP ASSISTANCE
The circularity (roundness) test

Graphic environment data to be configured

- Number of divisions on both sides of the theoretical circle.
- Scale or value in microns of each division.
- Error margin. Percentage of the area that is occupied by the error margin (divisions area).

See ["Machine parameter editing"](#) en la página 294.

Movement subroutine

The circular interpolation is carried out using a subroutine. See ["Define and execute the movement subroutine"](#) en la página 310.

The following data is taken into consideration when executing the subroutine.

- Plane where the circle is executed.
- Circle center coordinates.
- Circle radius.
- Programmed feedrate.
- Turning direction.

Parameters to be set

To make the adjustment, it is possible to change the CNC machine parameters or the drive machine parameters involved. See ["Adjustment of the machine parameters involved"](#) en la página 313.

It is possible to interact with up to 11 different machine parameters. Some of these parameters are always visible, but some may be defined at will. For each parameter, it shows its value on each axis of the work plane.

To see the whole list of parameters that may be defined, see section ["12.3.8 Machine parameters that may be modified"](#).

Softkey menu

Horizontal softkey menu

The horizontal softkey menu offers the following options.

- ❑ Softkey SIMPLE.
It captures the data of a full circle.
- ❑ Softkey CONTINUOUS.
It captures data continuously.
- ❑ Softkey STOP.
It stops the data capture. This softkey is shown when data capture is running.



This softkey only stops the data capture. It does not stop the movement of the axes. To stop the movement of the axes, press the [STOP] key of the operator panel.

- ❑ Softkey CLEAR.
It deletes the graphic representation. It may be done while the capture is running; in that case, it goes on with the graphic representation.
- ❑ Softkey LOAD.
It loads a previously saved configuration.
- ❑ Softkey SAVE.
It saves the configuration defined.

Vertical softkey menu

The vertical softkey menu offers the following options.



- ❑ Softkey VALIDATE.
It saves the values of the machine parameters in the tables of the CNC and/or the drive accordingly.
When changing the values of the machine parameters, the changes are effective immediately. However, these changes are maintained only during the current session of the CNC; i.e. until the unit is turned off. On power-up, it assumes the values stored in the tables.



- ❑ Softkey INITIALIZE.
It resets the window data to its default values.

12.

SETUP ASSISTANCE
The circularity (roundness) test

FAGOR

CNC 8070

(SOFT V02.0x)

12.3.2 Configuring and executing the circularity (roundness) test

12.

SETUP ASSISTANCE
The circularity (roundness) test

The process consists in executing a circle with the axes of the machine and verifying it on its graphic representation. The graphic shows the difference between the actual (real) coordinate obtained from the feedback device and the theoretical coordinate calculated in that point. This difference is shown projected radially.

The interpolation of the machine axes and the point capture for the graphics are initiated separately. The data capture is handled from the softkey menu whereas the movement of the axes is controlled from the operator panel.

The adjustment process is repeated until obtaining the best adjustment of the axes. The circularity (roundness) test diagram is an assistance tool that only shows the response of the system to the various settings (adjustments); it is up to the technician to choose the best adjustment.

How to execute the circularity (roundness) test

Basically it is done as follows. Each of these points is described in more detail in the indicated chapter.

The configuration used may be saved in a file for later.

1. Before initiating the process, certain aspects must be configured as well as the graphic environment, the circular interpolation, the values of the parameters involved, etc. See "[12.1.4 Machine parameter editing](#)" en la página 294.
A previously saved configuration may be used.
2. Execute a circular interpolation of the machine axes. The axes must be moving before the data capture starts. See "[12.3.4 Define and execute the movement subroutine](#)" en la página 310.
3. Initiate the data capture and the graphic simulation. Once the axes are moving, the data capture for the graphics may begin. While capturing data, the position error at each point is drawn on the graphics. See "[12.3.5 Data capture for the graphic](#)" en la página 311.
4. Optimize the adjustment by changing some machine parameters of the CNC or of the drive. This makes it possible to evaluate the system response to these changes and optimize the adjustment. See "[12.3.6 Adjustment of the machine parameters involved](#)" en la página 313.
5. Save the modified values and the configuration used. See "[12.3.7 Validate the changes and save the configuration used](#)" en la página 315.

Move through the data

To enter or modify a data, it must be selected; i.e. it must have the editing focus on it. To select a data, use the [←][→][↑][↓] keys.

The data are accepted with the [ENTER] key. Before accepting a data, it is checked out and if the data is not correct, it is not accepted.

12.3.3 Configure the graphic environment

This operation may be carried out before or during the test. If they are modified during the test, the screen is cleared and the graphic representation goes on.

The following graphic characteristics may be defined from the data window.

- Number of divisions on both sides of the theoretical circle.
- Scale or value in microns of each division.
- Error margin. Percentage of the area that is occupied by the error margin (divisions area).

Initialize the data

When accessing the circularity test, it assumes the values used last. Pressing the INITIALIZE softkey restores the default values.

Number of divisions	5
Scale:	10 microns/division
Error margin:	50 %



Bear in mind that the softkey INITIALIZE initializes all the data of the window, including the values of the machine parameters.

12.

SETUP ASSISTANCE
The circularity (roundness) test

12.3.4 Define and execute the movement subroutine

In order to run the test, the axes of the machine must be executing a circular interpolation. The axes must be moving before initiating the point capture and they must keep moving during the whole process. To achieve this, a repetitive movement must be executed.



The movement of the axes is managed from the operator panel. The softkey menu only controls the data capture for the graphics.

12.

SETUP ASSISTANCE
The circularity (roundness) test

Subroutine associated with the circularity test

The circular interpolation is executed with the subroutine associated with the circularity test. This subroutine is located in the folder "C:\CNC8070 \MTB \SUB \testcirc_vx.nc", where vx indicates the subroutine version and neither its name nor its location must be changed. This subroutine may be modified by the OEM to adapt it to his needs.

Some data of the subroutine are defined in this window.

- Plane where the circle is executed.
- Circle center coordinates.
- Circle radius.
- Programmed feedrate.
- Turning direction of the axes. The turning direction is given by an icon. To change the turning direction, place the focus on the icon and press [SPACE].

Execute the associated subroutine

Press the [START] key to execute the subroutine. The subroutine data cannot be modified while it is being executed. The movement must be stopped before editing any of the data.

When trying to execute the subroutine, if it is not in its pre-established location, the CNC interprets that it does not exist and it creates a predefined one.

Example of a subroutine

The following example executes a repetitive circular movement in the XY plane. In this case, the repetitive movement is carried out in an endless loop using the "GOTO" command. The movement is stopped with the [STOP] key of the operator panel.

```
%testcirc_V1
G1 G5 X0 Y0 F1000
N10:
    G2 X0 Y0 I10 J0
$GOTO N10
M29
```

12.3.5 Data capture for the graphic

Once the graphic representation has been defined and the machine axes are being interpolated, the point capture for the graphics may begin.

The point capture is initiated from the softkey menu. The point capture may be either simple, where the graph is made once (a single whole circle), or continuous where the graph is redrawn for every interpolation of the machine (after every whole circle).



When capturing points in the circularity test, they are not drawn on the graphics of the CNC.

The machine parameters may be modified while capturing points. See "**Adjustment of the machine parameters involved**" en la página 313.

Simple data capture

Data capture is initiated with the SIMPLE softkey. It deletes the graph and starts drawing the circularity error enlarged to the defined scale.

The capture ends after a whole circle or when the STOP softkey is pressed.

Continuous point capture

Data capture is initiated with the CONTINUOUS softkey. It deletes the graph and starts drawing the circularity error enlarged to the defined scale.

The capture ends when the STOP softkey is pressed.

When modifying the machine parameters, it is possible to see the new graph over the previous one or press the CLEAR key to only see the new one.

Stop the point capture

Press the STOP softkey to stop the data capture. It stops the simple or continuous data capture at any time.



This softkey only stops the data capture. It does not stop the movement of the axes. To stop the movement of the axes, press the [STOP] key of the operator panel.

Once the data capture is completed, two lines are drawn on the graph indicating the angular position of the maximum and minimum error.

Delete the graphic representation

Use the CLEAR softkey to delete the graph. It deletes the graph and the data shown over it.

It may be pressed at any time, even while it is being drawn.

12.

SETUP ASSISTANCE

The circularity (roundness) test



CNC 8070

(SOFT V02.0x)

12.3.6 Adjustment of the machine parameters involved

The best adjustment of the backlash peak may require modifying the value of certain machine parameters. This may be done directly in this window, thus without having to go to the machine parameter table.

When turning the CNC on, it assumes the new values in the CNC tables and/or in the drive tables accordingly. When changing these values, the changes are effective immediately and are assumed by the CNC until the unit is turned off. Once the setup is completed, the changes must be validated so they can be effective next time the CNC is turned on.

The parameters may be modified before or during the test.

Selection of the parameters to be displayed

It is possible to interact with up to 11 different machine parameters. Some of these parameters are always visible, but some may be defined at will. However, the CNC will only admit the valid parameters for this type of adjustment.

BACKLASH	
BAKANOUT	Additional velocity command pulse
BAKTIME	Duration of the additional velocity command pulse

To see the whole list of parameters that may be defined, see section ["12.3.8 Machine parameters that may be modified"](#). When using Fagor Sercos drives, the drive parameters may also be adjusted.

How to select the parameters

The parameter setting area shows three data columns. The parameters are defined in the first column. The rest of the fields show the parameter value for each axis.

The list of valid parameters is shown when editing a parameter or pressing [SPACE]. Use the [↑][↓] keys to move through the list and [ENTER] to select one of them. Once selected, the rest of the fields show the parameter value for each axis.

To select the parameters of the drive, simply write their names.

12.

SETUP ASSISTANCE
The circularity (roundness) test



CNC 8070

(SOFT V02.0x)

12.

SETUP ASSISTANCE
The circularity (roundness) test

Save the value of the parameters

The new data is assumed by the CNC until the unit is turned off. Once the setup is completed, the changes must be saved so they can be effective next time the CNC is turned on.

Use the VALIDATE softkey to save the data. The CNC saves the new values in the CNC tables and/or in the drive tables accordingly.

When quitting the circularity test without having saved the parameters, the CNC will show a message warning about it and will give a chance to save them.

Password-protected parameters

If the machine parameters are protected, a password will be requested when trying to modify them. If entered correctly, it stores it and it does not request it again unless the CNC is turned off. If the password is wrong, the values cannot be modified and it requests it again every time.

The test may be executed even when not knowing the access password, but the machine parameters cannot be changed.

The access passwords are determined from the utilities mode.

Initialize the value of the parameters

When turning the CNC on, it assumes the new values set by the manufacturer in the CNC tables and/or in the drive tables accordingly. The values used the last time will be kept for when accessing the test again later.

Pressing the INITIALIZE softkey sets the values assigned to the parameters as "default values" in the tables, not those set by the manufacturer.



Bear in mind that the INITIALIZE softkey initializes all the data of the window.

12.3.7 Validate the changes and save the configuration used

Validate the parameters

The new data is assumed by the CNC until the unit is turned off. Once the setup is completed, the changes must be saved so they can be effective next time the CNC is turned on.



Use the VALIDATE softkey to save the data. The CNC saves the new values in the CNC tables and/or in the drive tables accordingly.

When quitting the circularity test without having saved the parameters, the CNC will show a message warning about it and will give a chance to save them.

Save and load the configuration

The system permits saving the current configuration into a file in ASCII format (extension "TST"). This file only contains the configuration. It contains neither the graphics nor the values of the machine parameters. When loading a configuration, the parameters assume the value they have at that time.



The configuration saving option does not update the machine parameter table. To do that, use the VALIDATE softkey.

Save the configuration

Press the SAVE softkey to save the current configuration. Select the folder and the file name and press [ENTER]. If there is a configuration already saved with the same name, it will ask whether it is to be replaced or not.

By default, the configuration is saved in the folder "C:\CNC8070\MTB\DATA" or in the last folder selected by the user.

Load the configuration

Press the LOAD softkey to load a previously saved configuration. Select the folder and the file name and press [ENTER].

12.

SETUP ASSISTANCE
The circularity (roundness) test

12.3.8 Machine parameters that may be modified

General machine parameters

Parameter	Units	Update
PRELFITI	ms	Immediate
PRELOAD	%	Immediate
TCOMPLIM	%	Immediate
TINTIME	ms	Immediate
TPROGAIN	%	Immediate

Axis machine parameter

Parameter	Units	Update
BACKLASH	mm(inch) or degrees	Immediate
BAKANOUT	rpm	Immediate
BAKTIME	ms	Immediate
ACCEL	mm(inch)/s ² or degrees/s ²	Beginning of the next block
ACCJERK	mm(inch)/s ³ or degrees/s ³	Beginning of the next block
ACFGAIN	%	Immediate
ACFWFACTOR	ms	Immediate
DECEL	mm(inch)/s ² or degrees/s ²	Beginning of the next block
DECJERK	mm(inch)/s ³ or degrees/s ³	Beginning of the next block
FFGAIN	%	Immediate
G00FEED	mm(inch) or degrees	Beginning of the next block
INPOSW	mm(inch) or degrees	Immediate
LACC1	mm(inch)/s ² or degrees/s ²	Beginning of the next block
LACC2	mm(inch)/s ² or degrees/s ²	Beginning of the next block
LFEED	mm(inch) or degrees	Beginning of the next block
MANACFGAIN	%	Immediate
MANFFGAIN	%	Immediate
MAXVOLT	mV	Immediate
PROGAIN	1000/min	Immediate
SERVOOFF		Immediate

12.

SETUP ASSISTANCE
The circularity (roundness) test



CNC 8070

(SOFT V02.0x)

This operating mode may be used to set up Sercos drives by editing their parameters and variables.

DDSSetup mode selection



The DDSSetup mode may be accessed either using the user key customized for it or from the tasks window. The task window may be accessed with key combination [CTRL]+[A].

What can you do in this work mode?

In short, this operating mode offers the following operations:

- See the list of Sercos drives connected to the CNC.
- Change the access level for drive parameters.
- View and change the parameters and variables of the drives.
- Display the list of errors being generated by the drive.
- Monitor in real time the value of the drive variables.
- View the status of the operation being carried out at the drive and the status of the digital inputs and outputs.
- Generate velocity commands.

13.1 Appearance of the DDSSetup mode

When this operating mode is active, it will be indicated at the top right side of the general status bar.



This operating mode consists of several services. As these services are being activated, they overlap each other. If several services active, it is possible to switch from one to another using the relevant key, if it has been set accordingly.

The active services are switched in a rotary manner, in such a way that when pressing on the last active service, it shows the first one.

13.

DDSETUP

Appearance of the DDSSetup mode

13.1.1 Screen description

The DDSSetup screen shows the following information.

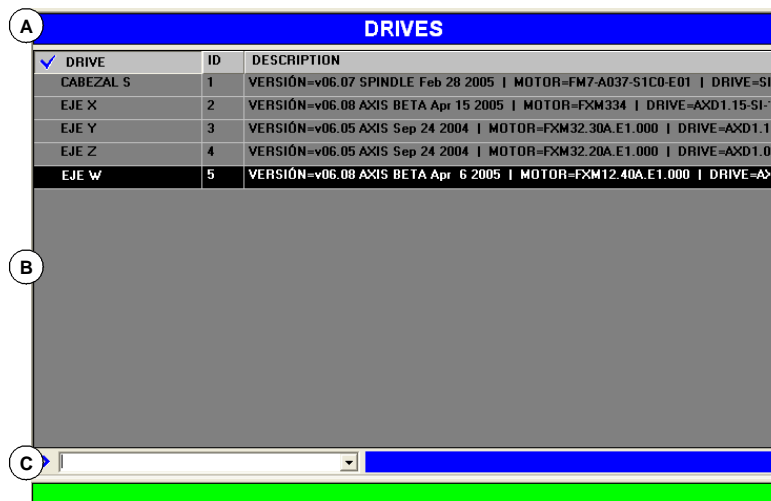

- A. Title bar that shows the name of the active service.
- B. Main window.
- C. Command bar.

13.

DDSSETUP
Appearance of the DDSSetup mode

13.1.2 Vertical softkey menu (icons)

13.

DDSS SETUP

Appearance of the DDSSetup mode



List of drives.

Shows the list of Sercos drives connected to the CNC. It shows a short description of each drive.



Drive accessing level change.

Change the access level for drive parameters and variables. This softkey shows a window that requests the password to quit the basic level and access a new level.



"Parameters and variables" service.

Shows the list of parameters and variables of the drive. You may choose whether to show the list of parameters, the list of variables or both.



"Error management" service.

It shows the list of errors detected by the drive. The errors are shown in the order they come up.

It is also possible to disable some errors.



"Monitoring" service.

It shows a list of variables that are selected by the user.



"Information" service.

This service monitors the status of the operation being carried out at the drive and the status of the digital inputs and outputs of the drive.



Command simulator.

This option may be used to configure and start up the internal command generator of the drive.



Select the command bar.

It directly selects the command bar of the DDSSetup. From the command bar, it is possible to execute different commands of the drive, check variables and modify their value if they may be written.

13.2 List of drives

This service shows a list of Sercos drives connected to the CNC. For each drive, it shows the name of the axis associated with it, its identifier and a short description for it, such as software version, motor ID and the ID of the drive itself.



This screen is the one shown by default when accessing the DDSSetup. It can also be accessed from any other service using the relevant softkey.

DRIVES		
DRIVE	ID	DESCRIPTION
✓ CABEZAL S	1	VERSIÓN=v06.07 SPINDLE Feb 28 2005 MOTOR=FM7-A037-S1C0-E01 DRIVE=SI
EJE X	2	VERSIÓN=v06.08 AXIS BETA Apr 15 2005 MOTOR=FXM334 DRIVE=AXD1.15-SI
EJE Y	3	VERSIÓN=v06.05 AXIS Sep 24 2004 MOTOR=FXM32.30A.E1.000 DRIVE=AXD1.1
EJE Z	4	VERSIÓN=v06.05 AXIS Sep 24 2004 MOTOR=FXM32.20A.E1.000 DRIVE=AXD1.0
EJE W	5	VERSIÓN=v06.08 AXIS BETA Apr 6 2005 MOTOR=FXM12.40A.E1.000 DRIVE=AX

The command bar is located at the bottom of the window. See "13.3 Command bar" en la página 322.

13.

DDSSETUP
List of drives

13.3 Command bar

The command bar is available in various services of the DDSSetup mode. From the command bar, it is possible to execute different commands of the drive, check variables and modify their value if they may be written.



The command bar may be selected with the window changing key, same as the rest of the screen elements or using its associated softkey.

Executing commands of the drive

The drop list offers the following commands. To execute one of them, select it from the list and press [ENTER].

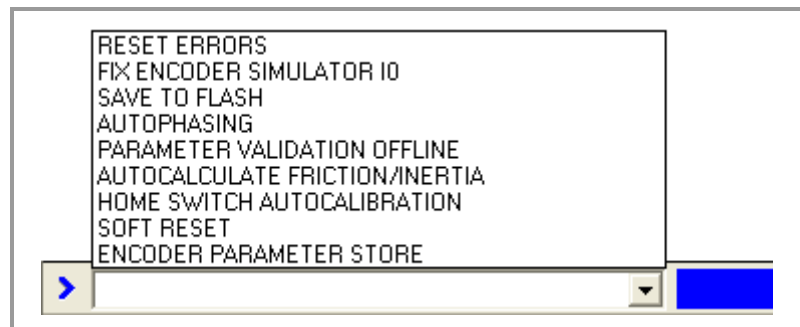

- Resetting errors.
- Setting the encoder simulator reference mark (I0).
- Transferring parameters from RAM to Flash.
- Autophasing.
- Validating.
- Calculating friction and inertia.
- Auto-calibration of the HomeSwitch .
- Soft Reset.
- Saving parameters at the encoder.

Consulting and modifying drive variables

Read-only variables may be consulted (those with the "R" indicator on the attributes column). Read-write variables may be consulted and/or edited (those with the "RW" indicator on the attributes column). See "[13.5 –Parameters and variables– service.](#)" en la página 325.

If a variable has been written, pressing [ENTER] reads its value. If a value is assigned to a variable, when pressing [ENTER], it assumes the new value.

13.

DDSETUP
Command bar

Variables may be identified using their mnemonic or their Sercos identifier. Refer to the drive's manual to know the list of available variables.

PV210	Consulting the PV210 variable.
S36	Consulting the variable SV1 (Sercos ID = 36).
RV9 = 23	It assigns the value of 23 to the variable RV9.
S36 = 100	It assigns the value of 100 to variable S36 (Sercos ID = 36).

If not indicated otherwise, it accesses the variables of the drive selected in the service. To access those of a particular drive, select it in the service or add a suffix with the axis name to the mnemonic (or Sercos ID).

PV210.Y	It consults the variable PV210 of the Y axis drive.
S36.S	Consulting variable (Sercos ID = 16) of the spindle drive.

13.

DDSETUP
Command bar



CNC 8070

(SOFT V02.0x)

13.4 Changing the drives accessing level

13.

DDSETUP

Changing the drives accessing level

The parameters, variables and commands of the drive are organized by access levels. To access each parameter, the drive must be configured at the access level required by that parameter. A password is needed to access each level.



This softkey is used to change the access level for drive parameters. Pressing this softkey shows a window that requests the password to quit the basic level and access a new level.

The available access levels are the following:

- Basic level (USER)

It is the default level, it is accessed when entering the DDSSetup mode. It requires no password.

The user level gives access to a group of parameters that slightly changes the operation of the drive.

- Intermediate level (OEM)

This level gives access to a large group of parameters that depend on the motor connected, they set how the electronics of the drive is adapted to that motor.

- Maximum level (FAGOR)

This level gives full access to all the variables, parameters and commands of the system.



The Fagor level gives access to a group of parameters depending on the drive's electronics and they factory set.

Only technicians from Fagor Automation are granted a FAGOR access level.

13.5 –Parameters and variables– service.



This service shows the list of parameters and/or variables of the drive. It is selected with the VIEW softkey of the horizontal menu.

PARÁMETERS					SPINDLE S
% DATOS INTERNOS					SET 0
MNEM...	VALUE	UNIT	RANGE	SID	NAME
%P1	0		[0..1]	F-0-52	%P1
%P111	18.77		[0.00..327.67]	S-0-119	%P111
%P112	1.775	mS	[0.000..32.767]	S-0-120	%P112
%P114	50.0	%	[10.0..1000.0]	F-0-28	%P114
%P115	100.0	%	[10.0..1000.0]	F-0-29	%P115

The command bar is located at the bottom of the window. See "[13.3 Command bar](#)" en la página 322.

Selection of the elements to be displayed

The VIEW softkey of the horizontal menu may be used to choose displaying either the parameters and variables, only the parameters or only the variables.

From the top of the window, it is possible to select:

- The drive whose parameters and/or variables are to be consulted.
- The group of parameters and/or variables to work with. Once selected, the list will show the elements of the selected group.
- The set of parameters to be consulted. Those parameters and/or variables that have sets will display the values of that set. Also, its identifier will show the selected set (e.g. for set 4 of the variable SP2, it will show SP2.4)

Parameters with a set will not be affected by the change.

List of variables and parameters

The list of variables and parameters offers the following information.

- Mnemonic of the variable or of the parameter.
- Current value at the drive.
- Units being used.
- Valid range of values. If it is a string of characters, it will show the maximum length permitted.
- Sercos identifier.
- Name of the variable or of the parameter.

13.

DDSSSETUP

–Parameters and variables– service.

FAGOR 

CNC 8070

(SOFT V02.0x)

13.

DDSETUP

–Parameters and variables– service.

Editing the values

The values, of parameters or variables with write permission are edited in the *Value* field. If the new value is accepted, the list shows the change.

The changes are saved in the drive's RAM memory. To save the change permanently, use the "DATA + FLASH" option of the horizontal menu.

How to make a backup copy of the data

The DATA softkey of the horizontal menu offers a series of options to make a backup copy of the values.

- The SAVE softkey saves the values of the parameters and variables into a file.
- The LOAD softkey restores the values of the parameters and variables from a previously saved file.

13.6 –Error management– service.



This service shows the list of errors detected by the drive. The errors are shown in the order they come up.

Once the cause of the error has been corrected, the errors may be reset with the ERROR RESET softkey of the horizontal menu.



The command bar is located at the bottom of the window. See "[13.3 Command bar](#)" en la página 322.

Disabling the errors

To disable an error of the drive, use the ERROR LISTING softkey of the horizontal menu. This softkey shows the whole list of possible errors. To disable the desired ones, checkmark the box on the left.

Then, press the SEND softkey to send the list to the drive. To make the error disabling effective, execute the command DC1 (reset errors) from the command bar.

Disabling the errors requires an OEM or FAGOR access level. See "[13.4 Changing the drives accessing level](#)" en la página 324. Even then, only resettable errors may be disabled, even if the list also shows the non-resettable errors.

13.

DDSSSETUP
–Error management– service.



CNC 8070

(SOFT V02.0x)

13.7 –Monitoring– service



This service monitors the value of the parameters and variables of the drive. The user selects the variables and parameters to be monitored.

MONITORING	
VARIABLE	VALUE
↑ GV25.5 (GV25)	
GV26.5 (GV26)	

The command bar is located at the bottom of the window. See "[13.3 Command bar](#)" en la página 322.

List of variables or parameters

The ADD softkey shows a window where one can select the variables or parameters to be monitored and they will be shown on the screen. Variables and parameters of any drive may be selected.

Use the INITIALIZE softkey to clear the whole list. To delete a variable or parameter from the list, select it and press the [DEL] key.

The SAVE softkey saves the list into a file and the LOAD softkey restores the list from a file.

Monitoring the status of variables or parameters

Press the START softkey of the horizontal menu to start monitoring. Press the STOP softkey to stop monitoring.

13.

DDSETUP
–Monitoring– service

13.8 –Information– service



This service monitors two types of information. It shows the status of the operation being carried out at the drive, on the other hand it shows the status of the digital inputs and outputs of the drive.

The command bar is located at the bottom of the window. See "[13.3 Command bar](#)" en la página 322.

Monitoring the status of the operations of the drive

The OPERATION STATUS softkey of the horizontal menu gives access to this option.

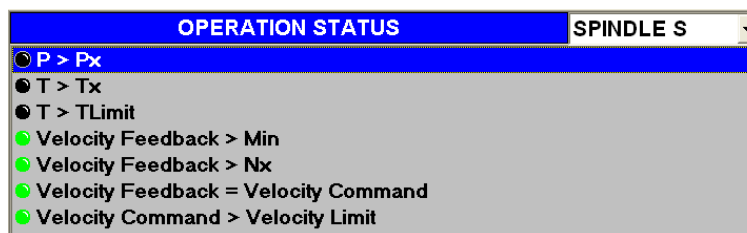

This screen monitors the status of the operation being carried out at the drive. The drive whose operations are to be monitored is selected at the top of the window.

There is a led for each operation and it shows the status of the operation at the drive.

- Green led Operation active.
- Black led Operation inactive.

Monitoring the status of the operations of the drive

The DIGITAL I/O softkey of the horizontal menu gives access to this option.

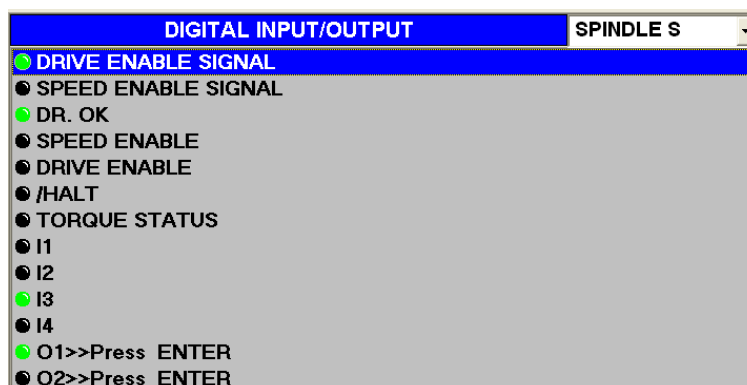

This screen monitors the status of the digital inputs and outputs of the drive. The drive whose digital I/O's are to be monitored is selected at the top of the window.

13.

DDSSSETUP
–Information– service



CNC 8070

(SOFT V02.0x)

13.

DDSETUP
 –Information– service

There is a led for each digital input and output of the drive and it shows its status.

- Green led Input or output active.
- Black led Input or output inactive.

Type of inputs and outputs

The inputs and outputs may be grouped as follows.

- Inputs and outputs that cannot be assigned.

These inputs and outputs indicate the status of the drive's control signals.

- Speed enable Drive enable Error Reset
- LSC Status DR. OK PROG. OK
- Master Speed Enable Master Drive Enable Master Halt
- Torque Status

- Inputs and outputs that may be assigned.

Variables and/or parameters of the drive may be associated with inputs and outputs (analog and digital).

Those digital outputs that have not been associated with any parameter or variable may be forced to become active or inactive using the button on the left of their led.

13.9 Command generator



This option may be used to configure and start up the internal command generator of the drive. In the configuration, it is possible to establish the shape of the signal, its amplitude, period, etc.

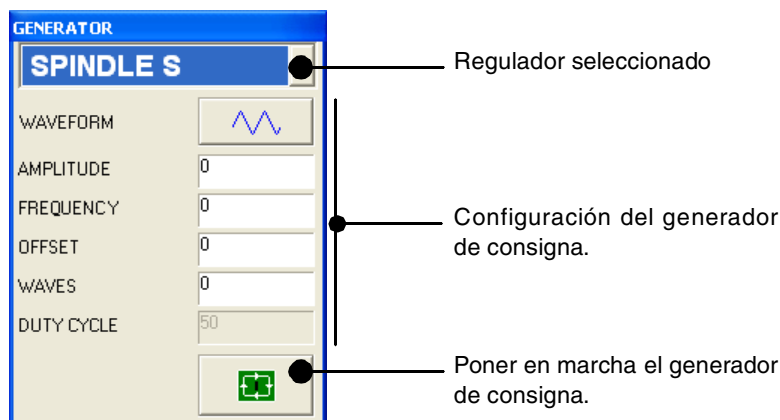

13.

DDSSSETUP
Command generator

The fields to be configured at the generator are:

- Shape To select the type of signal to be generated with the drive (sinusoidal or square).
- Amplitude Signal amplitude.
- Frequency Signal frequency.
- Offset Signal Offset.
- Waves Number of waves to generate. When set to 0 (zero), the waves are generated continuously, without interruption.
- Duty Cycle Percentage of the wave at 1/0 (only on squarewaves).

The internal command generator is turned on and off using the lower buttons.



It turns the command generator on.



It turns the command generator off.

13.

DDSETUP

Command generator



CNC 8070

(SOFT V02.0x)

This operating mode may be used to test the hardware and software of the PC that the CNC is based upon.

- System information.
- Information about the modules that make up the CNC software.
- Information about the elements connected to the CNC through the CAN bus and SERCOS.

The diagnosis is a testing and displaying tool; it cannot be used to modify the displayed values.

▼ Diagnosis mode selection



The diagnosis mode may be accessed either using the user key customized for it or from the tasks window. The task window may be accessed with key combination [CTRL]+[A].

14.1 Appearance of the diagnosis mode

When this operating mode is active, it will be indicated at the top right side of the general status bar.

This operating mode may be displayed with several screens. Each one corresponds to an element of the CNC configuration.

Standard configuration

The standard configuration of this work mode, described in this manual corresponds to the one supplied by Fagor. In some cases, the manual shows a sample screen, instead of that of the CNC in order to make it easier to understand.

14.

DIAGNOSIS
Appearance of the diagnosis mode

14.1.1 Screen description

The diagnosis screen shows the following information.

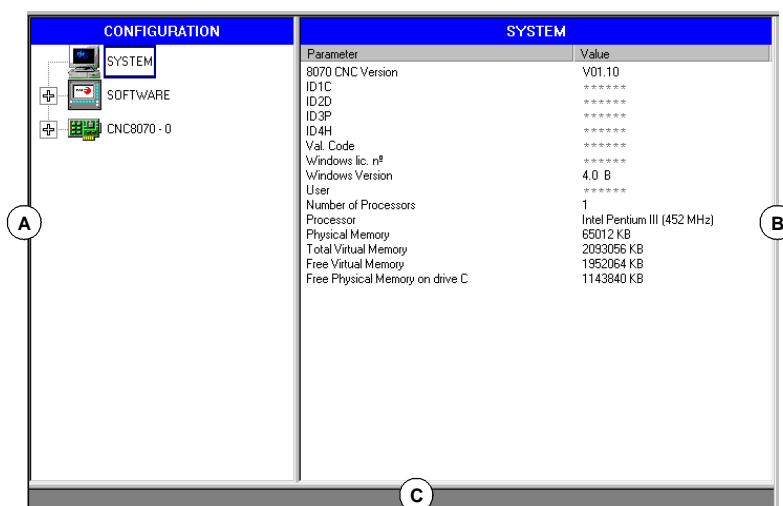

A. It shows the hardware and software configuration of the CNC.

System diagnosis: Information on the system elements; CNC version, user name, microprocessor(s) used, status of the various system memories, etc.

Software diagnosis: Information about the modules that make up the CNC software and the software options installed.







CNC8070 diagnosis: Information about the elements connected to the CNC through the Can bus and Sercos (drives, input/output cards, etc.).

B. Diagnosis of the selected element.

C. CNC messages.



To switch windows, press the relevant key.

After selecting an element of the configuration	
 	Hide or display the list of resources of an element.
 	To move the cursor through the elements of the list.
 	To move the cursor to the beginning or end of the list.

14.
DIAGNOSIS
 Appearance of the diagnosis mode

14.1.2 Icon description (vertical softkeys)

The icon menu always shows all the icons related to this work mode.

The icons are activated with their associated softkey (F8 to F12).

List of icons

Update data



It is used to update (refresh) the data of the diagnosis window.

Print table



It prints the information of the configuration out to a printer connected to the CNC or as a file at the CNC (in *.PRN format).

14.

DIAGNOSIS

Appearance of the diagnosis mode

14.2 Configuration diagnosis

14.2.1 System diagnosis

When selecting this configuration element, the diagnosis window shows the list of the system elements and their values.

The screenshot shows a software interface with a tree view on the left and a table on the right. The tree view has three main categories: SYSTEM, SOFTWARE, and CNC8070 - 0. The SYSTEM category is selected. The table on the right has two columns: 'Parameter' (labeled with a circled 'A') and 'Value' (labeled with a circled 'B').

Parameter (A)	Value (B)
8070 CNC Version	V01.10
ID1C	*****
ID2D	*****
ID3P	*****
ID4H	*****
Val. Code	*****
Windows lic. n°	*****
Windows Version	4.0 B
User	*****
Number of Processors	1
Processor	Intel Pentium III (452 MHz)
Physical Memory	65012 KB
Total Virtual Memory	2093056 KB
Free Virtual Memory	1952064 KB
Free Physical Memory on drive C	1143840 KB

(A) System elements.
(B) Element values.

14.

DIAGNOSIS
Configuration diagnosis

14.2.2 Software diagnosis

This option may be used to analyze the modules that make up the CNC software and the software options installed.

Module information

When selecting this configuration element, the diagnosis window shows the list of the modules that make up the CNC software.

14.
DIAGNOSIS
 Configuration diagnosis

CONFIGURATION		Modules			
SYSTEM		Name	Size	Date	
SOFTWARE		BootPC.exe	96 KB	16/01/2001	12:45:20
Modules		CNC8070.exe	302 KB	24/01/2001	15:44:44
Software options		DataMgr.exe	15 KB	19/01/2001	15:19:00
CNC8070 - 0		Iguim.exe	280 KB	24/01/2001	15:40:02
		HayConfCl.exe	94 KB	16/01/2001	12:54:16
		ItcBoot.exe	104 KB	16/01/2001	13:10:40
		ItcCAN.exe	127 KB	24/01/2001	15:47:22
		kernel.exe	2484 KB	24/01/2001	15:44:26
		RegDcx.exe	17 KB	12/12/2000	17:02:58
		WinKeyCtrl.exe	118 KB	19/01/2001	13:49:18
		xkernel.exe	517 KB	24/01/2001	15:46:52
		AnaGeom.dll	159 KB	23/01/2001	09:15:22
		Automat.dll	287 KB	24/01/2001	15:27:06
		caifresa.dll	170 KB	18/01/2001	15:05:50
		ciclos.dll	138 KB	24/01/2001	15:44:14
		cmprnmgri.dll	15 KB	24/01/2001	15:38:58
		compbase.dll	76 KB	24/01/2001	15:27:04
		Attributes		Value	
		Description			
		Type			
		Version			
		Product Name			
		Original Name			
		File OS			
		Copyright			

(A) Modules listing.
 (B) Detailed information of the selected module.

It shows the size of each module (in bytes) and the date it was created. When selecting a module from the list, the bottom of the screen shows more detailed information.

Software options

When selecting this element of the configuration, the diagnosis window shows the software options currently installed.

It also shows the horizontal softkey VALIDATION CODE for entering the resulting validation code according to the hardware ID of the unit and the desired options.



CNC 8070

(SOFT V02.0x)

14.2.3 Hardware diagnosis. CAN bus and SERCOS

When selecting this element of the configuration, the diagnosis window shows the software identification of the CNC's communications board (version, boot, checksum) and the type of buses connected to it. Likewise, it monitors the different voltage and temperature alarms.

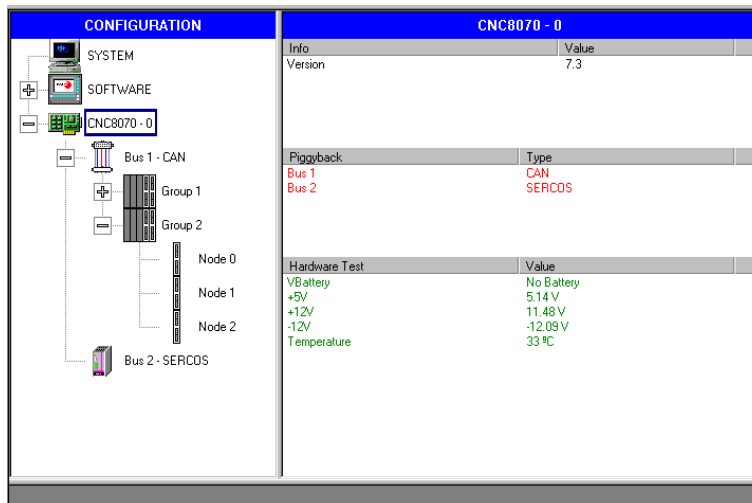

14.

DIAGNOSIS
Configuration diagnosis

Sercos bus configuration

- Listing of nodes and drive associated with each one of them.
For each drive, it indicates its software version, type of drive and the motor connected to it.

Can bus configuration

- Resources connected and their status.
- Groups connected and number of nodes that make up each group (detected and active).



Detailed information of the selected group.

- Group resources and their status.
- Information about the nodes that make up the group.

Detailed information of the selected node.

- Software version, boot and checksum of the code.
- Node status.
- Resources of each module.

The symbol next to the node indicates its status and its possible association.

-  Active.
-  Active, but in error.
-  Inactive.



CNC 8070

(SOFT V02.0x)

14.3 Sercos diagnosis

14.

DIAGNOSIS
Sercos diagnosis

General information about the bus

General purpose, it shows the following information about the Sercos bus.

Version	SERCON chip version.
Loop time	Time between two synchronization messages (MST). It is the same as general parameter LOOPTIME.
T2	Time from the MST until the CNC starts sending the telegram with the position commands (MDT).
T3	Time from the MST until the drives have the position commands.
T4	Time from the MST when the drives read the feedback values.
TL	Time from the MST until the RT IT takes place at the CNC.
Distortion errors	Distortion error counter at the CNC.
Ring errors	Sercos ring error counter.
Phase	Current Sercos phase.
Phase status	Phase status (0 = OK).
Logic ID and name	Name and driveID (number of the rotary switch) of the Sercos axes.

General information about the bus

It shows the following information for each drive.

General information

T1	Time from the MST until the drive starts sending its telegram (AT).
Control word	Contents of the drive's control word.
Status word	Contents of the drive's status word.
Name	Name of the Sercos axis.

Error information

"Reset Hard" counter	Number of times that the drive has been reset.
Distortion errors	Counter of distortion errors detected at the drive.
AT errors	Counters of AT reception errors of each drive.



CNC 8070

(SOFT V02.0x)

Information on the last operation carried out by the service channel

ID	Processed Sercos ID.
Element	Processed data (Name, Units, min/max Value, Status, Value, Attributes).
Process	Operation carried out (Read, Write).
Command status	In processes with commands, it indicates its status.
Error code	Operation error code (0 = OK).

14.

DIA GNOSIS
Sercos diagnosis



CNC 8070

(SOFT V02.0x)

14.4 Save the CAN configuration for the start-up test.

14.

DIAGNOSIS

Save the CAN configuration for the start-up test.

Saving a CAN configuration to a file serves to check the CAN configuration is correct when starting the system up. The CAN configuration must only be saved to a file after having verified that it is correct.

Save the CAN configuration.

When the CAN bus level is selected, it shows the SAVE softkey that may be used to save the current CAN configuration. The configuration is saved in the file C:\Cnc8070 \mtb \data \canData.tab.

This file contains the number of groups present in the bus, the number of modules, the number of inputs and outputs, etc.

Verify the CAN configuration during power-up.

To verify the configuration, the information must be previously saved to the file *canData.tab*.

During the power-up process, the data saved in the *canData.tab* file is compared with the data read during power-up. If when comparing the data, they are not the same, the corresponding error message is issued.

"The CAN configuration is not the same as the one saved in the file"

Once the error is detected, it will keep coming up even after a reset. There two ways to correct the error:

- Power up the CNC again with the original CAN configuration; the one saved in the *canData.tab* file
- Save the new CAN configuration. The CAN configuration must only be saved to a file after having verified that it is correct.

14.5 Generate a report with the system information

A report with all the information offered by the diagnosis mode may be obtained from any section of the diagnosis mode. This information may be printed or saved to a file.

This produces a document with all the information about the FAGOR system installed on a machine such as the software version, status of the remote modules, installed drives and motors, etc.



To print the information, use the "Print" icon. When pressing this icon, the CNC will show a dialog box requesting the print destination for the document (printer or file).

When printing to a file, it is possible to select the name and location of the file.

14.

DIAGNOSIS

Generate a report with the system information



FAGOR 

CNC 8070

(SOFT V02.0x)



CNC 8070

(SOFT V02.0x)